



Service Manual

DNG DC Inverter Series

Indoor Units	Outdoor Units
DNG 50 DCI	DCI 50
DNG 60 DCI	DCI 60
DNG 72 DCI	DCI 72
	DCI 72Z
DNG 80 DCI	DCI 80



Большая библиотека технической документации

<https://splitsystema48.ru/instrukcii-po-ekspluatacii-kondicionerov.html>

каталоги, инструкции, сервисные мануалы, схемы.

REFRIGERANT

R410A

HEAT PUMP

APRIL 2007

LIST OF EFFECTIVE PAGES

Note: Changes in the pages are indicated by a “Revision#” in the footer of each effected page (when none indicates no changes in the relevant page). All pages in the following list represent effected/ non effected pages divided by chapters.

Dates of issue for original and changed pages are:

Original 0 July 2006

Total number of pages in this publication is 122 consisting of the following:

Page No.	Revision No. #		Page No.	Revision No. #		Page No.	Revision No. #
----------	----------------	--	----------	----------------	--	----------	----------------

Title2
 A2
 i2
 1-1 - 1-42
 2-1 - 2-42
 3-12
 4-1 - 4-32
 5-1 - 5-202
 6-1 - 6-32
 7-1 - 7-42
 8-12
 9-1 - 9-42
 10-12
 11-12
 12-1- 12-222
 13-1-13-152
 14-1-14-92
 15-12

- Zero in this column indicates an original page.

* Due to constant improvements please note that the data on this service manual can be modified with out notice.

** Photos are not contractual.

Table of Contents

1. INTRODUCTION1-1

2. PRODUCT DATA SHEET2-1

3. RATING CONDITIONS3-1

4. OUTLINE DIMENSIONS4-1

5. PERFORMANCE DATA & PRESSURE CURVES5-1

6. AIRFLOW CURVES6-1

7. SOUND LEVEL CHARACTERISTICS7-1

8. ELECTRICAL DATA.....8-1

9. WIRING DIAGRAMS9-1

10. REFRIGERATION DIAGRAMS10-1

11. TUBING CONNECTIONS.....11-1

12. CONTROL SYSTEM12-1

13. TROUBLESHOOTING13-1

14. EXPLODED VIEWS AND SPARE PARTS LISTS.....14-1

15. APPENDIX A15-1

1. INTRODUCTION

1.1 General

The **DNG DCI** ducted split unit range comprises the following RC (heat pump) models

- **DNG 50**
- **DNG 60**
- **DNG 72**
- **DNG 80**

Remote control compatibility

- The **DNG** unit is compatible with remote controls RC3, RC4, RCW1, RCW2.

1.2 Main Features

The **DNG DCI** series benefits from the most advanced technological innovations, namely:

- DC inverter technology.
- R410A.
- High COP.
- Pre-Charged units up to the max' allowing tubing distance.
- A dry contact for presence detector or power shedding.
- Cooling operation at outdoor temperature down to -10°C.
- Heating operation at outdoor temperature down to -15°C.
- High Static Pressure in silhouette ducted unit
- Low silhouette 260-300mm height that simplify the false ceiling construction.
- Small volume ,easy for installation(require small space for installation).
- Built in over-flow protection against the condensate wate.
- Low indoor and outdoor noise levels.
- Water condensate tray is equipped with two optional drain connections.
- Microprocessor control.
- Infrared remote control with liquid crystal displa.
- Easy installation and service.

1.3 Indoor Unit

The indoor unit is a low silhouette ducted unit, and can be easily fitted to many types of residential and commercial applications.

It includes:

- High technology plastic fan and fan housing.
- A drain pool that is under the entire unit with internal downward slope.
- An over-flow switch, stops compressor operation in case of is blocked drainage.
- A bended coil with treated aluminium fins.
- 3-speed fan motor an extra speed in case a higher external static pressure is needed.
- Advanced electronic control box assembly.
- All the tubing connections are in the back of the unit to allow easy outlet to left or right side of the unit.
- Field options:
 - (1) External water pump
 - (2) Airconet connection
 - (3) Plenum kit for connection of flexible hoses at air outlet.

1.4 Filtration

- The unit is equipped with pre filters.
- Easy and versatile access, rear or bottom, can be easily adjusted by the installer.

1.5 Ionizer (Optional)

A special design Ioniser protected by unique patents integrated into the indoor unit, generating negative ions to the room providing comfort and upgraded indoor air quality.

1.6 Control

The microprocessor indoor controller, and an infrared remote control, supplied as standard, provide complete operating function and programming.

For further details, please refer to the Operation Manual, Appendix A.

1.7 Outdoor Unit

The **DNG DCI INV** outdoor units can be installed as floor or wall mounted units by using a wall supporting bracket. The metal sheets are protected by anti- corrosion paint work allowing long life resistance. All outdoor units are pre-charged. For further information, please refer to the Product Data Sheet, Chapter 2.

It includes:

- Compressor mounted in a soundproofed compartment :
Scroll – for DNG 50, 60
Dual Rotary – for DNG 72, 80
- Improved 3- blades axial fans for noise reduction.
- Fan grill air outlet.
- Service valves "flare" type connection.
- Service ports for high/ low pressure measurement.
- Advanced controller.
- Outdoor coil with hydrophilic louver fins.

Feature	DCI50, 60,72, 72Z, 80
Diagnostics Display	3 LED`s
Outdoor Fan	Variable speed DC Inverter
M2L cable Port	No

1.8 Tubing Connections

Flare type-interconnecting tubing to be produced on site.
 All the units from 7KW and up can be installed with 50-meter tubing length and 25-meter height difference without oil traps.
 For further details, please refer to the Installation Manual, Appendix A.

1.9 Accessories

RCW Wall Mounted Remote Control

The RCW remote control is mounted on the wall, and controls the unit either as an infrared remote control or as a wired controller. The wired controller can control up to 10 Indoor units with the same program settings and adjustments.
 For further details, please refer to the Technical Service Manual.

1.10 Inbox Documentation

Each unit includes its own installation and operation manuals.

1.11 Matching Table

1.11.1 R410A

OUTDOOR UNITS			INDOOR UNITS			
	MODEL	REFRIGER.	DNG 50 DCI	DNG 60 DCI	DNG 72 DCI	DNG 80 DCI
	DCI 50	R410A	√			
	DCI 60	R410A		√		
	DCI 72 DCI 72Z	R410A			√	
	DCI 80	R410A				√

The above table lists outdoor units and DNG/DCI indoor units which can be matched together. In addition the listed outdoor units can be matched with other types of indoor units such as cassettes, floor/ceiling.

For further information please refer to the relevant Service Manual.

2. PRODUCT DATA SHEET

2.1 DNG50 DCI

Model Indoor Unit		DNG 50 DCI		
Model Outdoor Unit		DCI 50 R410A		
Installation Method of Pipe		Flared		
Characteristics	Units	Cooling	Heating	
Capacity ⁽¹⁾	Btu/hr	17060(5460-21840)	20470(4780-26270)	
	kW	5.0(1.6 - 6.4)	6.0(1.4 - 7.7)	
Power input ⁽¹⁾	kW	1.55(0.5- 2.2)	1.6(0.4- 2.0)	
EER (Cooling) or COP(Heating) ⁽¹⁾	W/W	3.23	3.75	
Energy efficiency class		A	A	
Power supply	V/Ph/Hz	220-240V/Single/50Hz		
Rated current	A	6.7	7.0	
Starting current	A	15		
Circuit breaker rating	A	20		
INDOOR	Fan type & quantity		Centrifugal x 1	
	Fan speeds	H/M/L	RPM	630/530/425
	Air flow ⁽²⁾	H/M/L	m3/hr	1170/920/730
	External static pressure	Min-Max	Pa	25-60
	Sound power level ⁽³⁾	H/M/L	dB(A)	55/53/50
	Sound pressure level ⁽⁴⁾	H/M/L	dB(A)	42/37/34
	Moisture removal		l/hr	1.0
	Condensate drain tube I.D		mm	19
	Dimensions	WxHxD	mm	790x256x749
	Weight		kg	29
	Package dimensions	WxHxD	mm	959x315x854
	Packaged weight		kg	31
	Units per pallet		units	6
	Stacking height		units	6
OUTDOOR	Refrigerant control		EEV	
	Compressor type, model		Scroll, Panasonic 5CS130XCC03	
	Fan type & quantity		Propeller(direct) x 1	
	Fan speeds	H/L	RPM	920
	Air flow	H/L	m3/hr	2160
	Sound power level ⁽³⁾	H/L	dB(A)	63
	Sound pressure level ⁽⁴⁾	H/L	dB(A)	53
	Dimensions	WxHxD	mm	795x610x290
	Weight		kg	39
	Package dimensions	WxHxD	mm	945x655x395
	Packaged weight		kg	43
	Units per pallet		Units	9 units per pallet
	Stacking height		units	3 levels
	Refrigerant type			R410A
	Refrigerant charge(standard connecting tubing length)		Kg(m)	1.50
	Additional charge per 1 meter		g/m	No need
Connections between units	Liquid line	In.(mm)	1/4"(6.35)	
	Suction line	In.(mm)	1/2"(12.7)	
	Max.tubing length	m.	Max.30	
	Max.height difference	m.	Max. 15	
Operation control type			Remote control	
Heating elements		kW		
Others				

- (1) Rating conditions in accordance with ISO 5151 and ISO 13253 (for ducted units).
- (2) Airflow in ducted units; at nominal external static pressure.
- (3) Sound power in ducted units is measured at air discharge.
- (4) Sound pressure level measured at 1.4 meter distance from unit.

2.2 DNG60 DCI

Model Indoor Unit		DNG 60 DCI	
Model Outdoor Unit		DCI 60 R410A	
Installation Method of Pipe		Flared	
Characteristics		Units	Cooling Heating
Capacity ⁽¹⁾		Btu/hr	19110(5460-22520) 22520(6140-27300)
		kW	5.6 (1.6 - 6.6) 6.6 (1.8 - 8.0)
Power input ⁽¹⁾		kW	1.86(0.5 - 2.25) 1.80 (0.5 - 2.08)
EER (Cooling) or COP(Heating) ⁽¹⁾		W/W	3.01 3.74
Energy efficiency class			B A
Power supply		V/Ph/Hz	220-240V/Single/50Hz
Rated current		A	8.1 7.8
Starting current		A	15
Circuit breaker rating		A	20
INDOOR	Fan type & quantity		Centrifugal x 1
	Fan speeds	H/M/L	RPM 680/530/425
	Air flow ⁽²⁾	H/M/L	m3/hr 1210/875/730
	External static pressure	Min-Max	Pa 25-60
	Sound power level ⁽³⁾	H/M/L	dB(A) 60/53/50
	Sound pressure level ⁽⁴⁾	H/M/L	dB(A) 43/37/34
	Moisture removal		l/hr 1.24
	Condensate drain tube I.D		mm 19
	Dimensions	WxHxD	mm 790x250x749
	Weight		kg 29
	Package dimensions	WxHxD	mm 959x315x854
	Packaged weight		kg 31
	Units per pallet		units 6
	Stacking height		units 6
OUTDOOR	Refrigerant control		EEV
	Compressor type, model		Scroll, Panasonic 5CS130XCC03
	Fan type & quantity		Propeller(direct) x 1
	Fan speeds	H/L	RPM 820
	Air flow	H/L	m3/hr 2860
	Sound power level ⁽³⁾	H/L	dB(A) 65
	Sound pressure level ⁽⁴⁾	H/L	dB(A) 55
	Dimensions	WxHxD	mm 846x690x302
	Weight		kg 46
	Package dimensions	WxHxD	mm 990x770x430
	Packaged weight		kg 50
	Units per pallet		Units 9 units per pallet
	Stacking height		units 3 levels
	Refrigerant type		R410A
	Refrigerant charge(standard connecting tubing length)		Kg(7.5m) 1.65
	Additional charge per 1 meter		g/m No need
	Connections between units	Liquid line	In.(mm)
Suction line		In.(mm)	1/2"(12.7)
Max.tubing length		m.	Max.30
Max.height difference		m.	Max. 15
Operation control type		Remote control	
Heating elements		kW	
Others			

- (1) Rating conditions in accordance with ISO 5151 and ISO 13253 (for ducted units).
- (2) Airflow in ducted units; at nominal external static pressure.
- (3) Sound power in ducted units is measured at air discharge.
- (4) Sound pressure level measured at 1.4 meter distance from unit.

2.3 DNG72 DCI

Model Indoor Unit		DNG 72 DCI	
Model Outdoor Unit		DCI 72 R410A	
Installation Method of Pipe		Flared	
Characteristics		Units	Cooling Heating
Capacity ⁽¹⁾		Btu/hr	23200(5460-27300) 25930(6140-30030)
		kW	6.8(1.6-8.0) 7.6(1.8-8.8)
Power input ⁽¹⁾		kW	2.26(0.55 - 2.68) 2.08(0.5 - 2.5)
EER (Cooling) or COP(Heating) ⁽¹⁾		W/W	3.01 3.65
Energy efficiency class			B A
Power supply		V/Ph/Hz	220-240V/Single/50Hz
Rated current		A	9.8 9.0
Starting current		A	15
Circuit breaker rating		A	20
INDOOR	Fan type & quantity		Centrifugal x 1
	Fan speeds	H/M/L	RPM 800/670/550
	Air flow ⁽²⁾	H/M/L	m3/hr 1320/1150/935
	External static pressure	Min-Max	Pa 25-60
	Sound power level ⁽³⁾	H/M/L	dB(A) 65/60/55
	Sound pressure level ⁽⁴⁾	H/M/L	dB(A) 47/43/38
	Moisture removal		l/hr 1.53
	Condensate drain tube I.D		mm 19
	Dimensions	WxHxD	mm 790x256x749
	Weight		kg 29
	Package dimensions	WxHxD	mm 959x315x854
	Packaged weight		kg 31
	Units per pallet		units 6
	Stacking height		units 6
OUTDOOR	Refrigerant control		EEV
	Compressor type, model		Two Rotary, Mitsubishi TNB220F
	Fan type & quantity		Propeller(direct) x 1
	Fan speeds	H/L	RPM 850
	Air flow	H/L	m3/hr 3600
	Sound power level ⁽³⁾	H/L	dB(A) 66
	Sound pressure level ⁽⁴⁾	H/L	dB(A) 56
	Dimensions	WxHxD	mm 950x835x412
	Weight		kg 65.5
	Package dimensions	WxHxD	mm 1080x910x477
	Packaged weight		kg 73
	Units per pallet		Units 2
	Stacking height		units 2 levels
	Refrigerant type		R410A
	Refrigerant charge (standard connecting tubing length)		kg(7.5m) 2.4
	Additional charge (tubing length 30-50m)		Kg 1.8
	Connections between units	Liquid line	In.(mm)
Suction line		In.(mm)	5/8"(15.88)
Max.tubing length		m.	Max.50
Max.height difference		m.	Max.25
Operation control type		Remote control	
Heating elements		kW	
Others			

- (1) Rating conditions in accordance with ISO 5151 and ISO 13253 (for ducted units).
- (2) Airflow in ducted units; at nominal external static pressure.
- (3) Sound power in ducted units is measured at air discharge.
- (4) Sound pressure level measured at 1.4 meter distance from unit.

2.4 DNG72Z DCI

Model Indoor Unit		DNG 72 DCI													
Model Outdoor Unit		DCI 72 Z R410A													
Installation Method of Pipe		Flared													
Characteristics		Units	<table border="1"> <thead> <tr> <th>Cooling</th> <th>Heating</th> </tr> </thead> <tbody> <tr> <td>23200(5460-27300)</td> <td>25930(6140-30030)</td> </tr> <tr> <td>6.80(1.60-8.00)</td> <td>7.60(1.80~8.80)</td> </tr> <tr> <td>2.26(0.58-2.90)</td> <td>2.08(0.50~2.50)</td> </tr> <tr> <td>3.01</td> <td>3.65</td> </tr> <tr> <td>B</td> <td>A</td> </tr> </tbody> </table>	Cooling	Heating	23200(5460-27300)	25930(6140-30030)	6.80(1.60-8.00)	7.60(1.80~8.80)	2.26(0.58-2.90)	2.08(0.50~2.50)	3.01	3.65	B	A
Cooling	Heating														
23200(5460-27300)	25930(6140-30030)														
6.80(1.60-8.00)	7.60(1.80~8.80)														
2.26(0.58-2.90)	2.08(0.50~2.50)														
3.01	3.65														
B	A														
Capacity ⁽¹⁾		Btu/hr													
		kW													
Power input ⁽¹⁾		kW													
EER (Cooling) or COP(Heating) ⁽¹⁾		W/W													
Energy efficiency class															
Power supply		V	220-240												
		Ph	Single												
		Hz	50												
Rated current		A	10.0 9.2												
Power factor			0.97 0.97												
Prated (IDU)		W	260												
Prated (IDU+ODU)		W	3000												
Starting current		A	15												
Circuit breaker rating		A	20												
INDOOR	Fan type & quantity		Centrifugal x 1												
	Fan speeds	H/M/L	RPM												
	Air flow ⁽²⁾	H/M/L	m3/hr												
	External static pressure	Min	Pa												
	Sound power level ⁽³⁾	H/M/L	dB(A)												
	Sound pressure level ⁽⁴⁾	H/M/L	dB(A)												
	Moisture removal		l/hr												
	Condensate drain tube I.D		mm												
	Dimensions	WxHxD	mm												
	Net Weight		kg												
	Package dimensions	WxHxD	mm												
	Packaged weight		kg												
	Units per pallet		units												
	Stacking height		units												
OUTDOOR	Refrigerant control		EEV												
	Compressor type,model		Two Rotary,Sanyo(Sheny) C-7RVN153H0W												
	Fan type & quantity		Propeller(direct) x 1												
	Fan speeds	H	RPM												
	Air flow	H	m3/hr												
	Sound power level	H	dB(A)												
	Sound pressure level ⁽⁴⁾	H	dB(A)												
	Dimensions	WxHxD	mm												
	Net Weight		kg												
	Package dimensions	WxHxD	mm												
	Packaged weight		kg												
	Units per pallet		Units												
	Stacking height		units												
	Refrigerant type		R410A												
	Standard charge		kg(7.5m)												
	Additional charge		7.5m≤Length≤20m:+0g; 20m≤Length≤30m:+300g; 30m≤Length≤50m:+1500g;												
	Connections between units	Liquid line	In.(mm)	3/8"(9.53)											
Suction line		In.(mm)	5/8"(15.88)												
Max.tubing length		m.	50												
Max.height difference		m.	25												
Operation control type			Remote control												
Heating elements		kW													
Others															

- (1) Rating conditions in accordance with ISO 5151 and ISO 13253 (for ducted units).
- (2) Airflow in ducted units; at nominal external static pressure.
- (3) Sound power in ducted units is measured at air discharge.
- (4) Sound pressure level measured at 1.4 meter distance from unit.

2.5 DNG80 DCI

Model Indoor Unit		DNG 80 DCI	
Model Outdoor Unit		DCI 80 R410A	
Installation Method of Pipe		Flared	
Characteristics		Units	Cooling Heating
Capacity ⁽¹⁾		Btu/hr	25590(5460-30710) 30030(6140-35830)
		kW	7.5(1.6-9.0) 8.8(1.8-10.5)
Power input ⁽¹⁾		kW	2.48(0.55-3.15) 2.44(0.5-2.8)
EER (Cooling) or COP(Heating) ⁽¹⁾		W/W	3.02 3.61
Energy efficiency class			B A
Power supply		V/Ph/Hz	220-240V/Single/50Hz
Rated current		A	11.3 10.6
Starting current		A	15
Circuit breaker rating		A	20
INDOOR	Fan type & quantity		Centrifugal x 1
	Fan speeds	T/H/M/L	RPM 800/670/550
	Air flow ⁽²⁾	T/H/M/L	m3/hr 1420/1150/935
	External static pressure	Min-Max	Pa 25-80
	Sound power level ⁽³⁾	H/M/L	dB(A) 64/61/58
	Sound pressure level ⁽⁴⁾	H/M/L	dB(A) 48/44/40
	Moisture removal		l/hr 2.5
	Condensate drain tube I.D		mm 19
	Dimensions	WxHxD	mm 790x256x749
	Weight		kg 31
	Package dimensions	WxHxD	mm 959x315x854
	Packaged weight		kg 33
	Units per pallet		units 6
	Stacking height		units 6
	OUTDOOR	Refrigerant control	
Compressor type, model		Two Rotary, Mitsubishi TNB220F	
Fan type & quantity		Propeller(direct) x 1	
Fan speeds		H/L	RPM 850
Air flow		H/L	m3/hr 3600
Sound power level ⁽³⁾		H/L	dB(A) 66
Sound pressure level ⁽⁴⁾		H/L	dB(A) 56
Dimensions		WxHxD	mm 950x835x412
Weight			kg 66
Package dimensions		WxHxD	mm 1080x910x477
Packaged weight			kg 73.5
Units per pallet			Units 2
Stacking height			units 2 levels
Refrigerant type		R410A	
Refrigerant charge(standard connecting tubing length)		Kg(7.5m) 2.75	
Additional charge (tubing length 30-50 m)		g/m 1.45	
Connections between units		Liquid line	In.(mm)
	Suction line	In.(mm)	5/8"(15.88)
	Max.tubing length	m.	Max.50
	Max.height difference	m.	Max.25
Operation control type		Remote control	
Heating elements		kW	
Others			

- (1) Rating conditions in accordance with ISO 5151 and ISO 13253 (for ducted units).
- (2) Airflow in ducted units; at nominal external static pressure.
- (3) Sound power in ducted units is measured at air discharge.
- (4) Sound pressure level measured at 1.4 meter distance from unit.

3. RATING CONDITIONS

Standard conditions in accordance with ISO 5151 and ISO 13253 (for ducted units) and EN 14511.

Cooling:

Indoor: 27°C DB 19°C WB

Outdoor: 35°C DB

Heating:

Indoor: 20°C DB

Outdoor: 7°C DB 6°C WB

3.1 Operating Limits

		Indoor	Outdoor
Cooling	Upper limit	32°C DB 23°C WB	46°C DB
	Lower limit	21°C DB 15°C WB	-10°C DB
Heating	Upper limit	27°C DB	24°C DB 18°C WB
	Lower limit	10°C DB	-15°C DB -16°C WB
Voltage	1PH	198 – 264V	

4. OUTLINE DIMENSIONS

4.1 Indoor Unit: DNG 50, 60, 72, 80

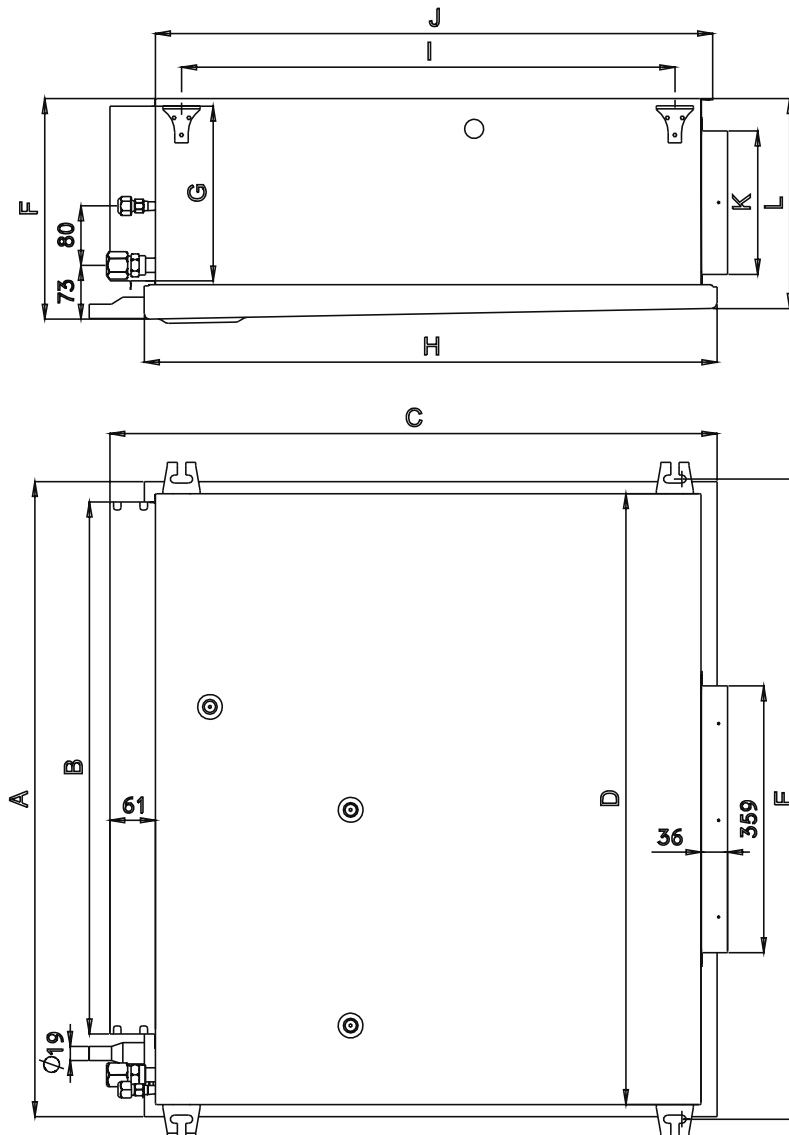

Model	A	B	C	D	E	F	G	H	I	J	K	L
DNG50,60,72,80	790	653	749	758	797	256	195	702	599	684	162	242

4.2 Outdoor Unit: DCI 50

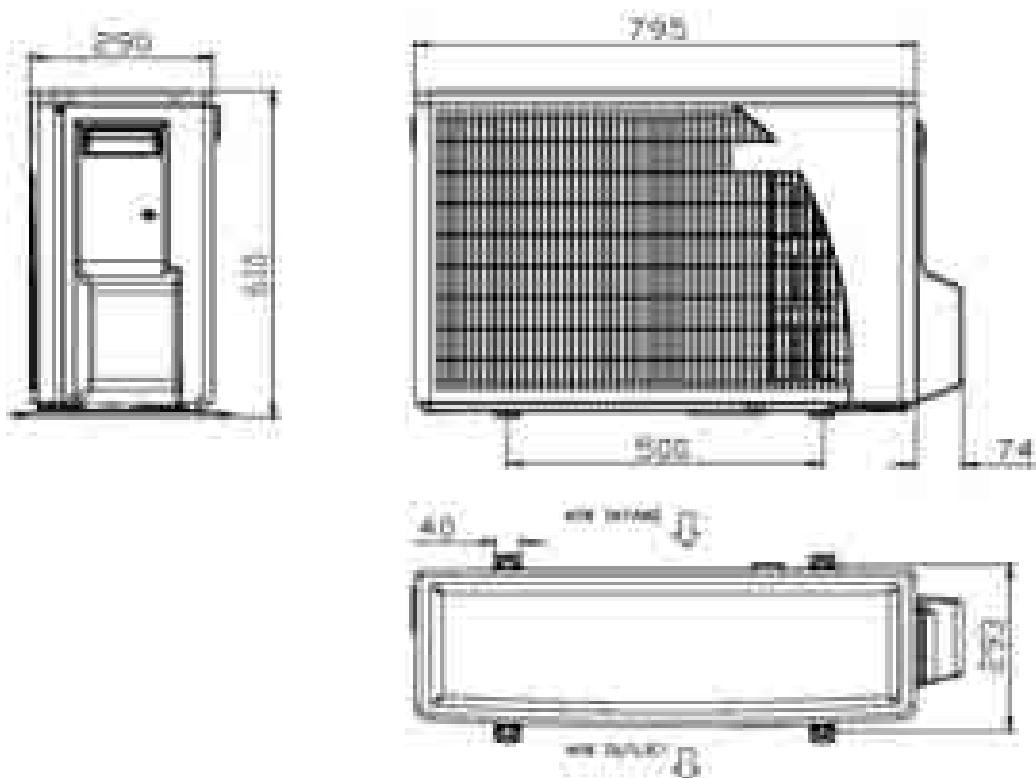

4.3 Outdoor Unit: DCI 60

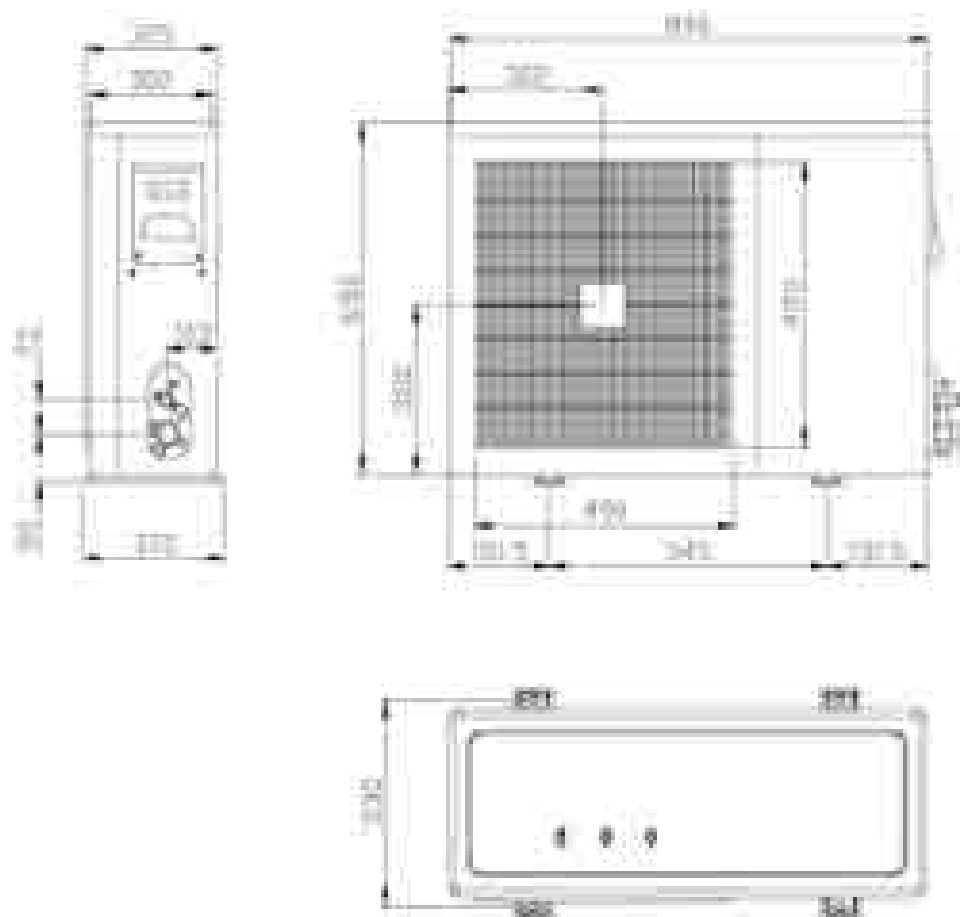

4.4 Outdoor Unit: DCI 72/80

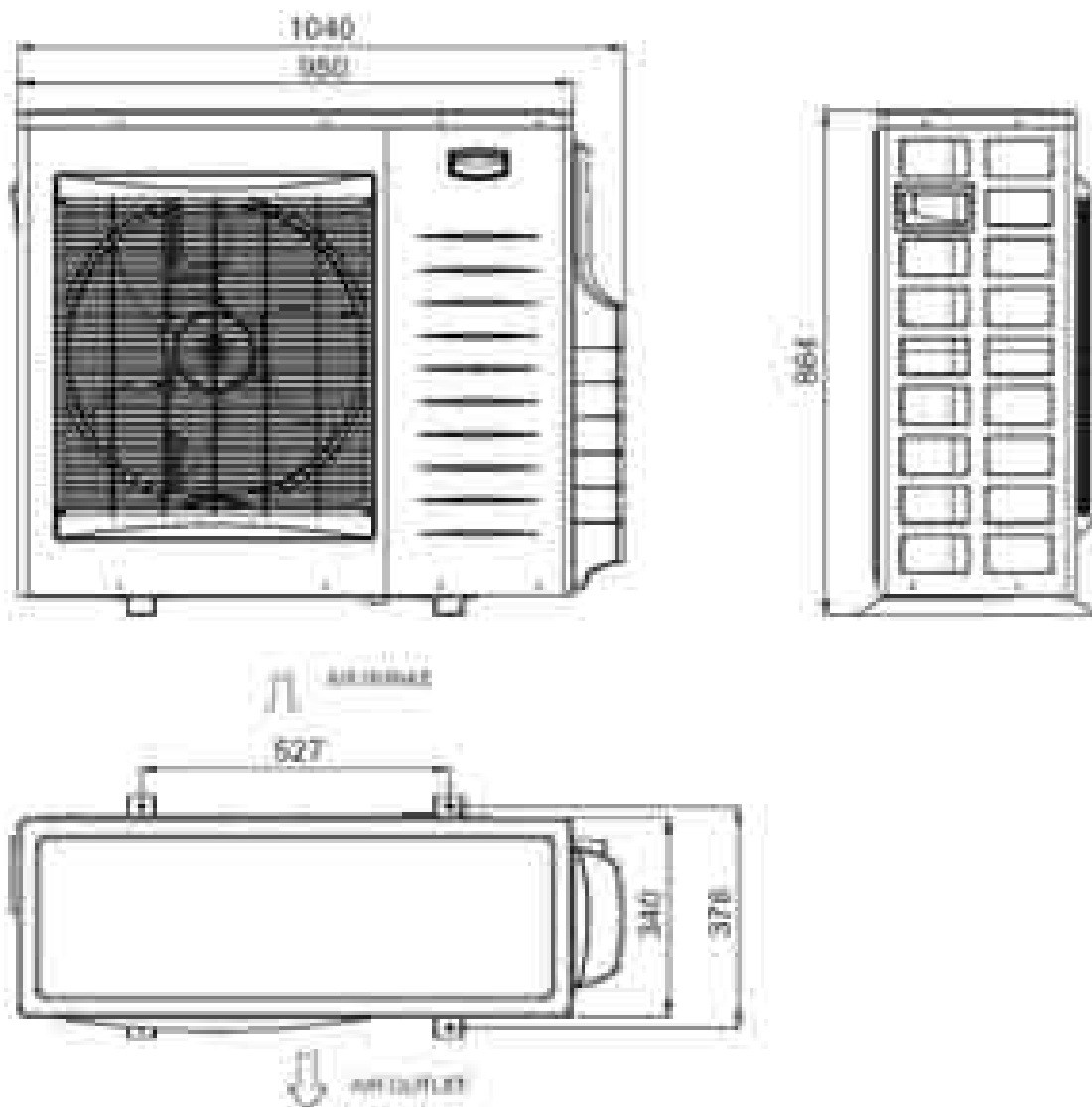

5. PERFORMANCE DATA & PRESSURE CURVES

5.1 DNG50 DCI / DCI 50

5.1.1 Cooling Capacity (kW)

OD COIL ENTERING AIR DB TEMPERATURE [C°]	DATA	ID COIL ENTERING AIR DB/WB TEMPERATURE [C°]				
		22/15	24/17	27/19	29/21	32/23
-10 - 20 (protection range)	TC	80 - 110 % of nominal				
	SC	80 - 105 % of nominal				
	PI	25 - 50 % of nominal				
25	TC	4.83	5.15	5.47	5.78	6.10
	SC	4.39	4.48	4.57	4.66	4.75
	PI	1.22	1.24	1.26	1.29	1.31
30	TC	4.60	4.92	5.23	5.55	5.86
	SC	4.28	4.37	4.46	4.55	4.64
	PI	1.36	1.38	1.41	1.43	1.45
35	TC	4.37	4.68	5.00	5.32	5.63
	SC	4.17	4.26	4.35	4.44	4.53
	PI	1.50	1.53	1.55	1.57	1.60
40	TC	4.14	4.45	4.77	5.08	5.40
	SC	4.06	4.15	4.24	4.33	4.42
	PI	1.65	1.67	1.69	1.72	1.74
46	TC	3.86	4.17	4.49	4.80	5.12
	SC	3.93	4.02	4.11	4.20	4.29
	PI	1.82	1.84	1.86	1.89	1.91

LEGEND

- TC – Total Cooling Capacity, kW
- SC – Sensible Capacity, kW
- PI – Power Input, kW
- WB – Wet Bulb Temp., (°C)
- DB – Dry Bulb Temp., (°C)
- ID – Indoor
- OD – Outdoor

5.1.2 Capacity Correction Factors (Cooling)

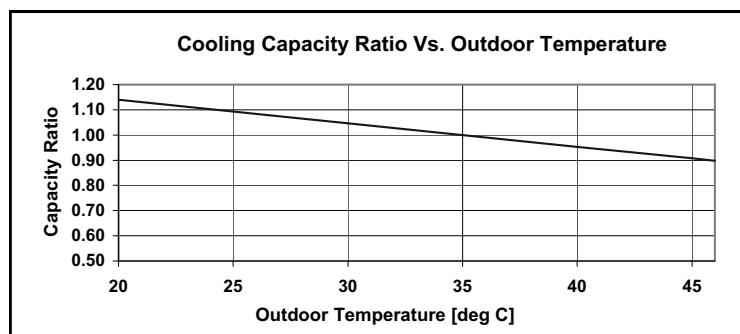

5.1.3 Heating

OD COIL ENTERING AIR DB/WB TEMPERATURE [C°]	DATA	ID COIL ENTERING AIR DB TEMPERATURE [C°]		
		15	20	25
-15/-16	TC	3.82	3.55	3.29
	PI	0.96	1.06	1.16
-10/-12	TC	4.25	3.98	3.72
	PI	1.16	1.26	1.35
-7/-8	TC	4.58	4.31	4.04
	PI	1.31	1.40	1.50
-1/-2	TC	4.74	4.47	4.20
	PI	1.38	1.48	1.57
2/1	TC	4.85	4.58	4.31
	PI	1.43	1.53	1.62
7/6	TC	6.27	6.00	5.73
	PI	1.50	1.60	1.70
10/9	TC	6.61	6.35	6.08
	PI	1.59	1.69	1.79
15/12	TC	6.96	6.69	6.42
	PI	1.68	1.78	1.88
15-24 (Protection Range)	TC	85 - 105 % of nominal		
	PI	80 - 120 % of nominal		

LEGEND

- TH – Total Heating Capacity, kW
- PI – Power Input, kW
- WB – Wet Bulb Temp., (°C)
- DB – Dry Bulb Temp., (°C)
- ID – Indoor
- OD – Outdoor

5.1.4 Capacity Correction Factors (Heating)

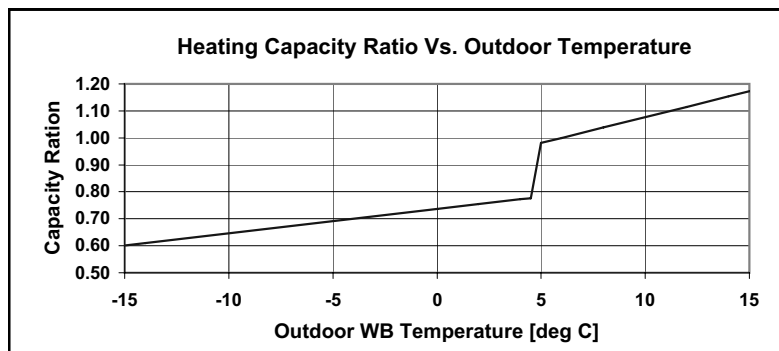

5.1.5 Pressure Curves (Cooling – Test Mode)

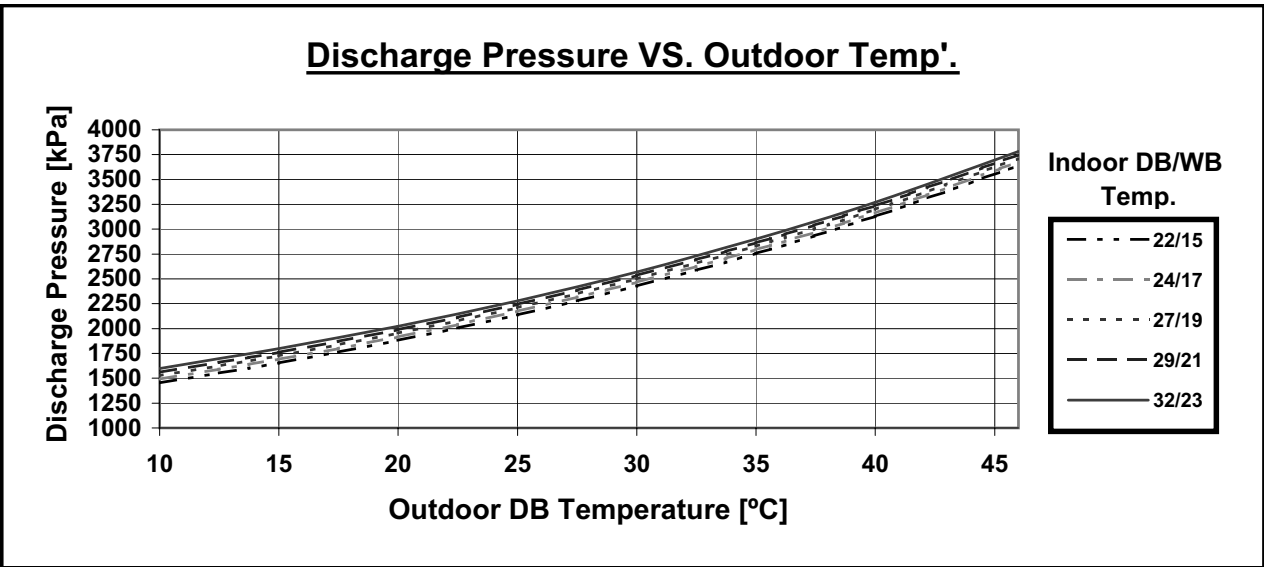
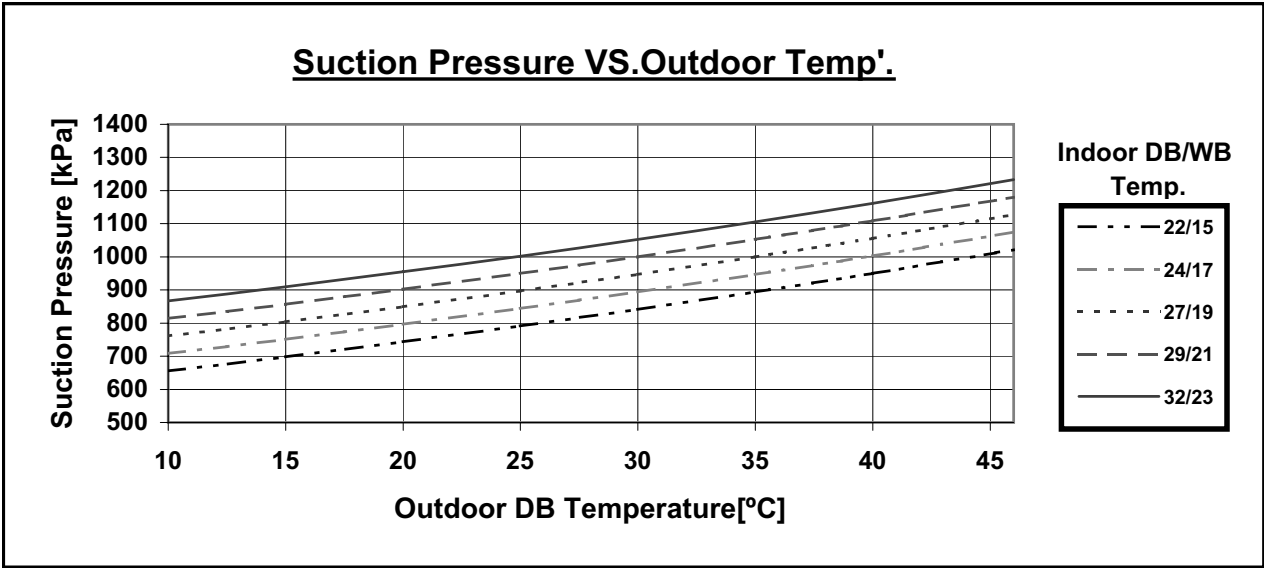

5.1.6 Pressure Curves (Heating – Test Mode)

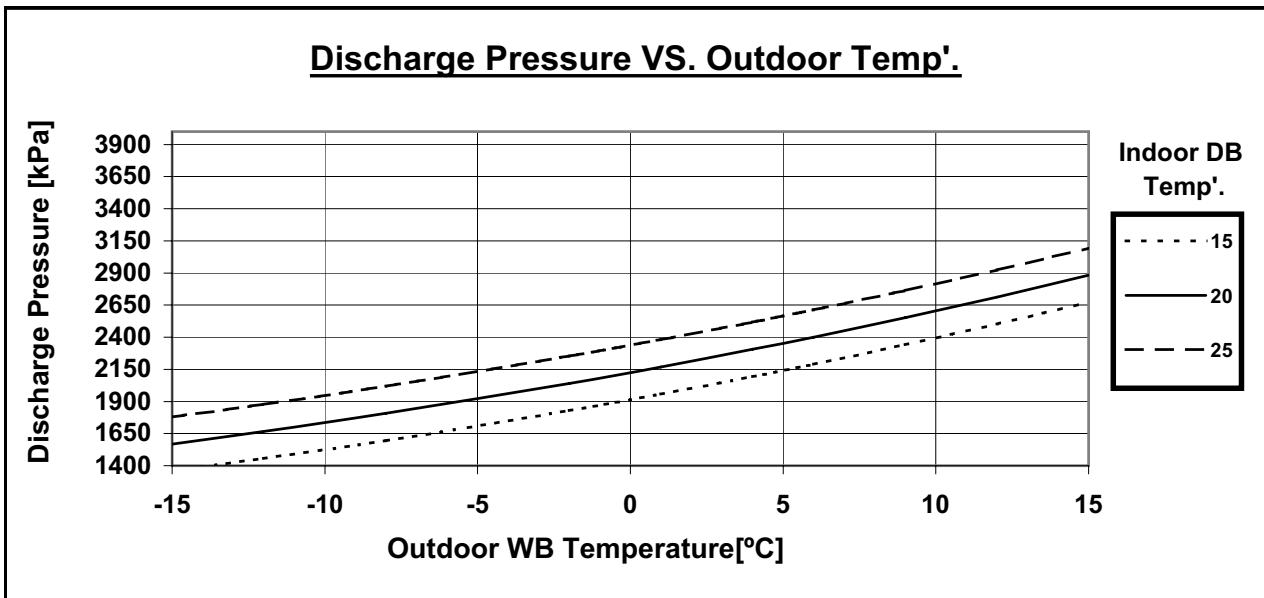
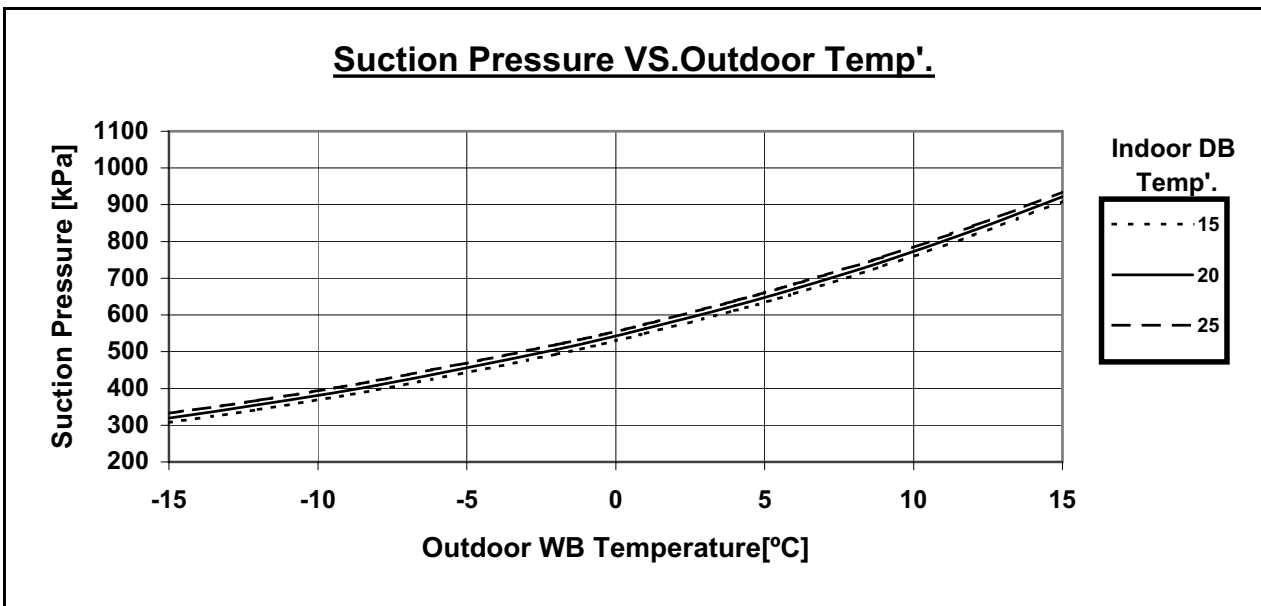

5.1.7 Capacity Correction Factor Due to Tubing Length
Cooling

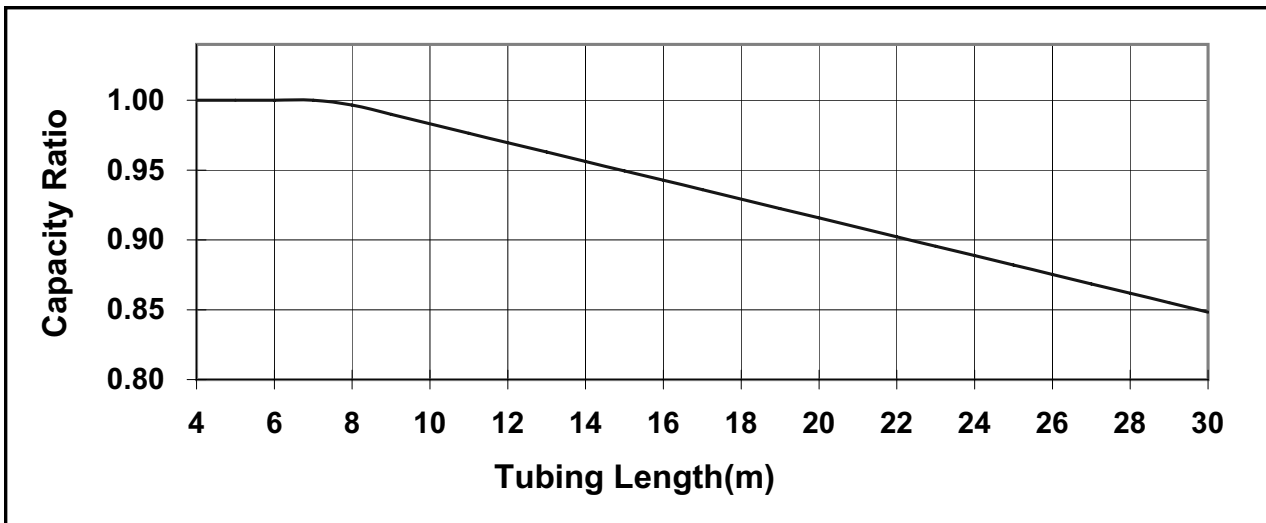

Heating

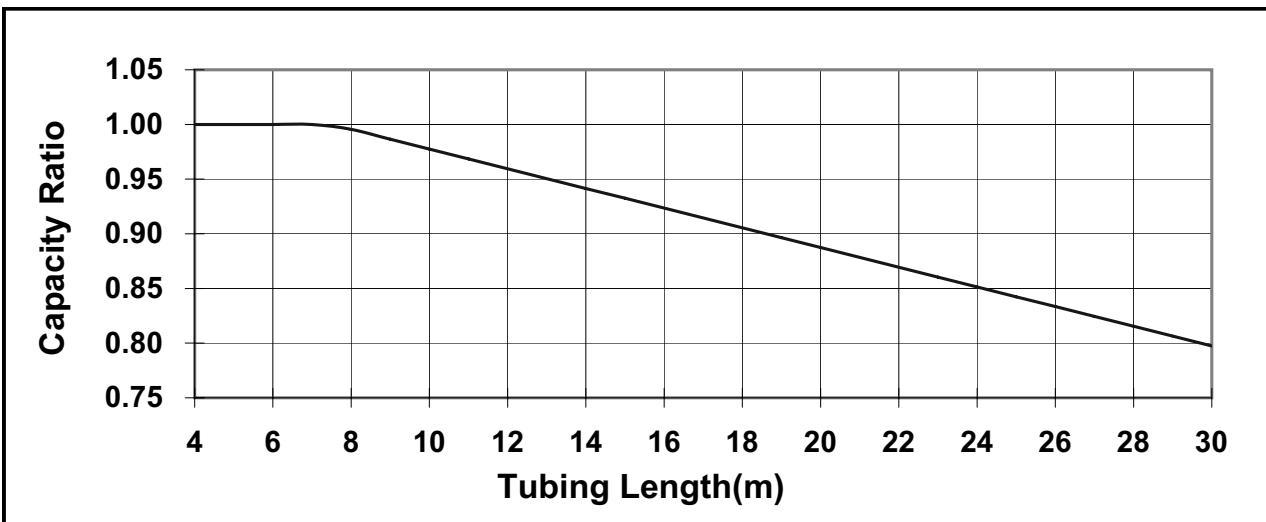

5.2 DNG60 DCI / DCI 60

5.2.1 Cooling Capacity (kW)

OD COIL ENTERING AIR DB TEMPERATURE [C°]		DATA	ID COIL ENTERING AIR DB/WB TEMPERATURE [C°]				
			22/15	24/17	27/19	29/21	32/23
-10 - 20 (protection range)	TC	80 - 110 % of nominal					
	SC	80 - 105 % of nominal					
	PI	25 - 50 % of nominal					
25	TC	5.41	5.77	6.12	6.47	6.83	
	SC	4.81	4.90	5.00	5.10	5.20	
	PI	1.46	1.49	1.52	1.55	1.57	
30	TC	5.15	5.51	5.86	6.21	6.57	
	SC	4.69	4.78	4.88	4.98	5.08	
	PI	1.63	1.66	1.69	1.72	1.74	
35	TC	4.89	5.25	5.60	5.95	6.31	
	SC	4.56	4.66	4.76	4.86	4.96	
	PI	1.80	1.83	1.86	1.89	1.92	
40	TC	4.63	4.99	5.34	5.69	6.05	
	SC	4.44	4.54	4.64	4.74	4.83	
	PI	1.98	2.00	2.03	2.06	2.09	
46	TC	4.32	4.67	5.03	5.38	5.74	
	SC	4.30	4.40	4.49	4.59	4.69	
	PI	2.18	2.21	2.24	2.26	2.29	

LEGEND

- TC – Total Cooling Capacity, kW
- SC – Sensible Capacity, kW
- PI – Power Input, kW
- WB – Wet Bulb Temp., (°C)
- DB – Dry Bulb Temp., (°C)
- ID – Indoor
- OD – Outdoor

5.2.2 Capacity Correction Factors (Cooling)

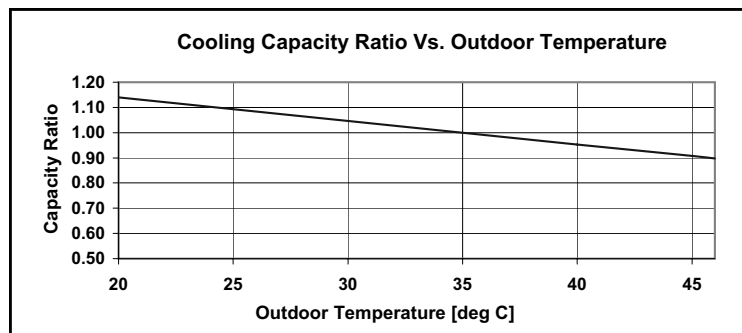

5.2.3 Heating

OD COIL ENTERING AIR DB/WB TEMPERATURE [C°]	DATA	ID COIL ENTERING AIR DB TEMPERATURE [C°]		
		15	20	25
-15/-16	TC	4.20	3.91	3.61
	PI	1.08	1.19	1.30
-10/-12	TC	4.68	4.38	4.09
	PI	1.30	1.41	1.52
-7/-8	TC	5.03	4.74	4.45
	PI	1.47	1.58	1.69
-1/-2	TC	5.21	4.92	4.62
	PI	1.55	1.66	1.77
2/1	TC	5.33	5.04	4.74
	PI	1.61	1.72	1.83
7/6	TC	6.89	6.60	6.31
	PI	1.69	1.80	1.91
10/9	TC	7.27	6.98	6.69
	PI	1.79	1.90	2.01
15/12	TC	7.65	7.36	7.07
	PI	1.89	2.00	2.11
15-24 (Protection Range)	TC	85 - 105 % of nominal		
	PI	80 - 120 % of nominal		

LEGEND

- TH – Total Heating Capacity, kW
- PI – Power Input, kW
- WB – Wet Bulb Temp., (°C)
- DB – Dry Bulb Temp., (°C)
- ID – Indoor
- OD – Outdoor

5.2.4 Capacity Correction Factors (Heating)

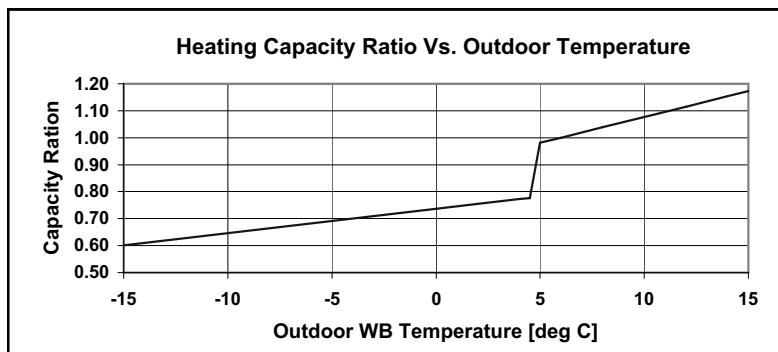

5.2.5 Pressure Curves (Cooling – Test Mode)

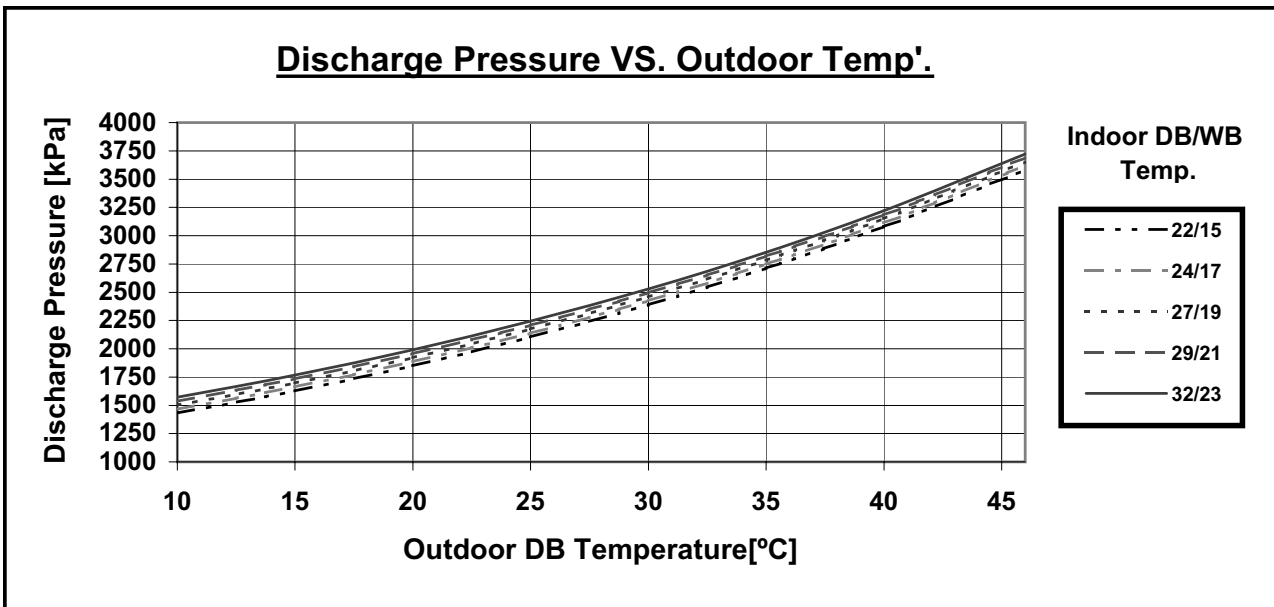
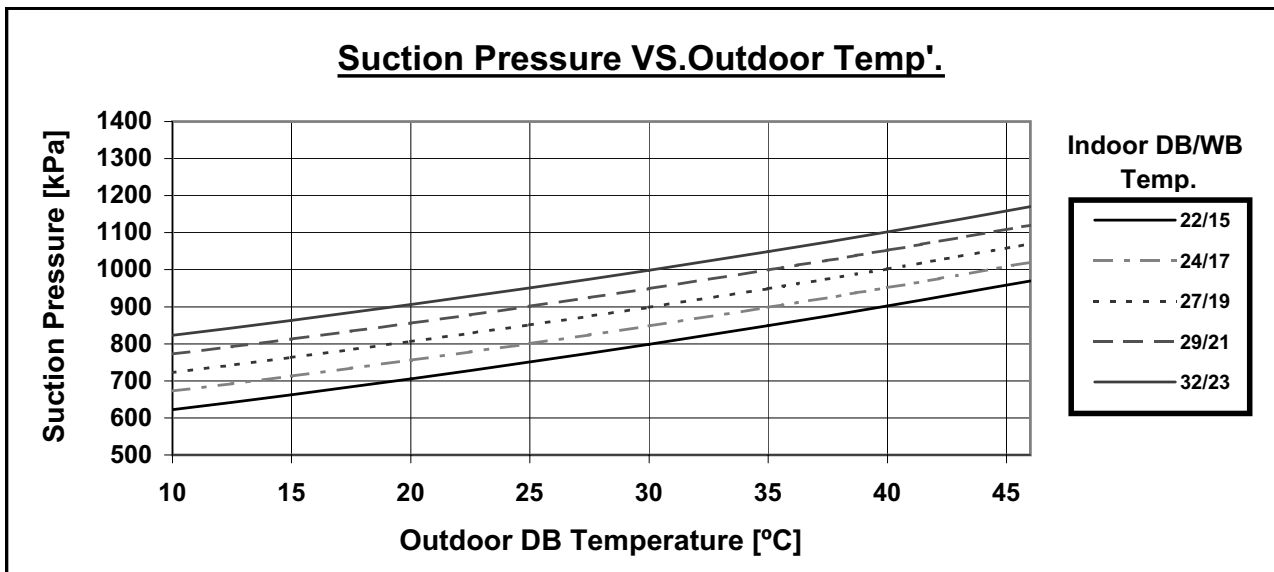

5.2.6 Pressure Curves (Heating – Test Mode)

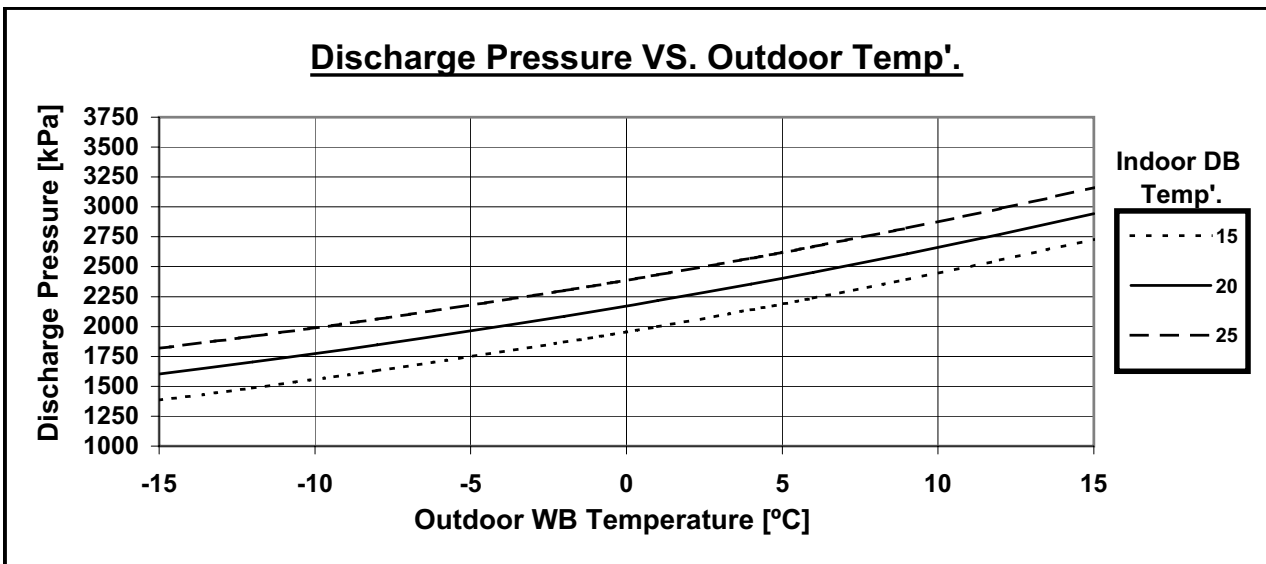
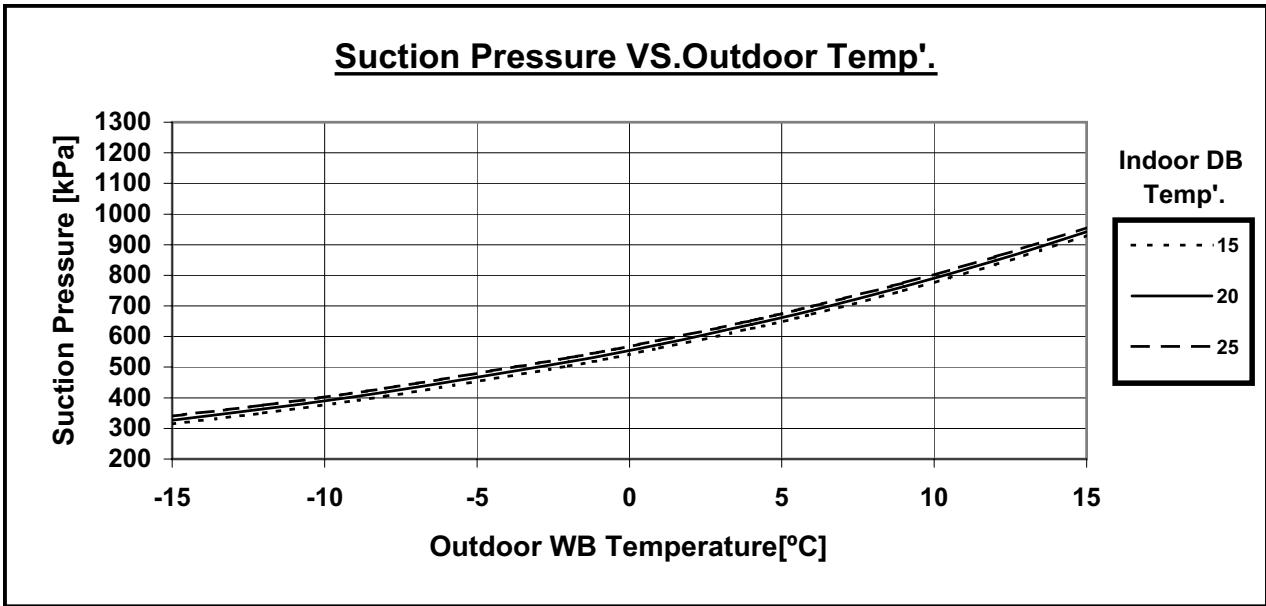

5.2.7 Capacity Correction Factor Due to Tubing Length
Cooling

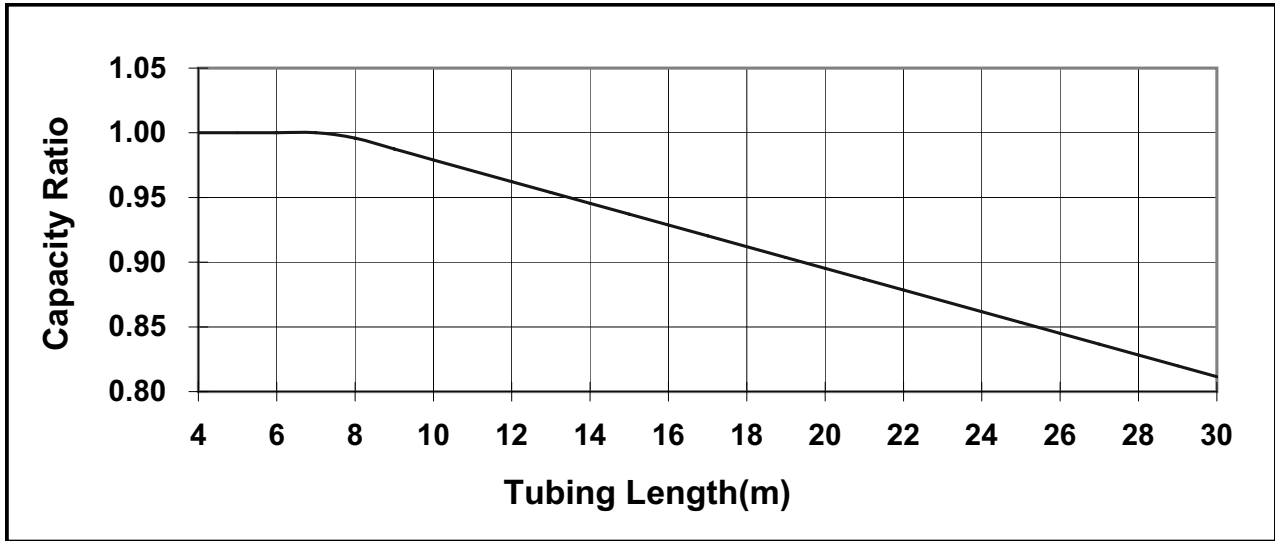

Heating

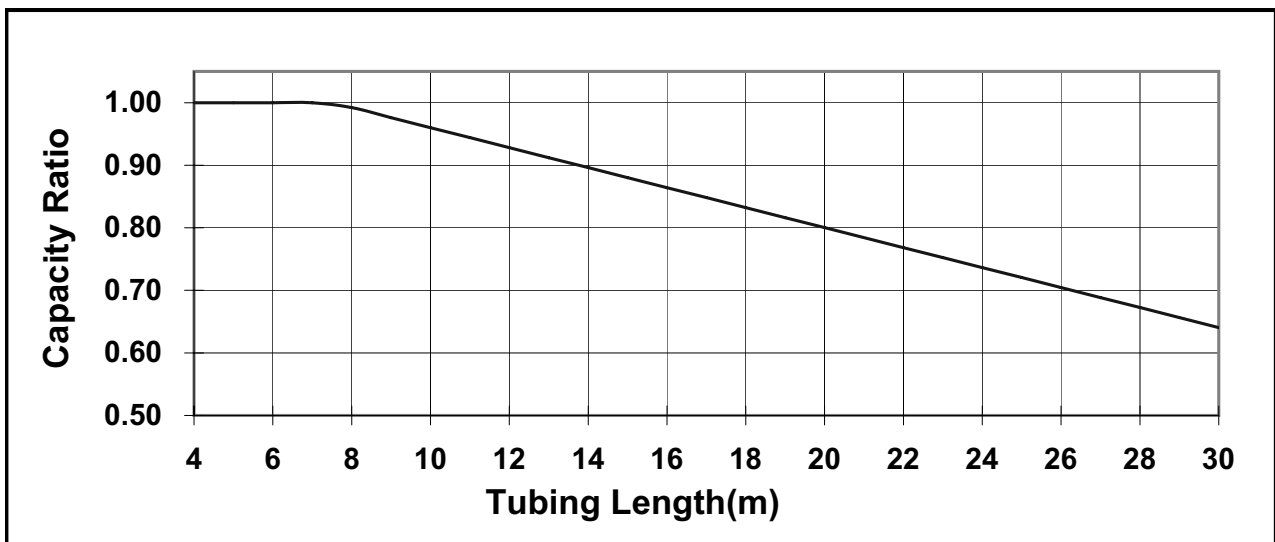

5.3 DNG72 DCI / DCI72, DNG72 DCI / DCI 72Z

5.3.1 Cooling Capacity (kW)

OD COIL ENTERING AIR DB TEMPERATURE [C°]		ID COIL ENTERING AIR DB/WB TEMPERATURE [C°]				
		22/15	24/17	27/19	29/21	32/23
-10 - 20 (protection range)	TC	80 - 110 % of nominal				
	SC	80 - 105 % of nominal				
	PI	25 - 50 % of nominal				
25	TC	6.57	7.00	7.43	7.86	8.29
	SC	5.83	5.95	6.06	6.18	6.30
	PI	1.78	1.81	1.84	1.88	1.91
30	TC	6.26	6.69	7.12	7.55	7.98
	SC	5.68	5.80	5.92	6.04	6.15
	PI	1.98	2.02	2.05	2.09	2.12
35	TC	5.94	6.37	6.80	7.23	7.66
	SC	5.53	5.65	5.77	5.89	6.01
	PI	2.19	2.23	2.26	2.29	2.33
40	TC	5.62	6.05	6.48	6.91	7.34
	SC	5.39	5.50	5.62	5.74	5.86
	PI	2.40	2.43	2.47	2.50	2.54
46	TC	5.24	5.67	6.10	6.53	6.96
	SC	5.21	5.33	5.45	5.57	5.68
	PI	2.65	2.68	2.72	2.75	2.79

LEGEND

- TC – Total Cooling Capacity, kW
- SC – Sensible Capacity, kW
- PI – Power Input, kW
- WB – Wet Bulb Temp., (°C)
- DB – Dry Bulb Temp., (°C)
- ID – Indoor
- OD – Outdoor

5.3.2 Capacity Correction Factors (Cooling)

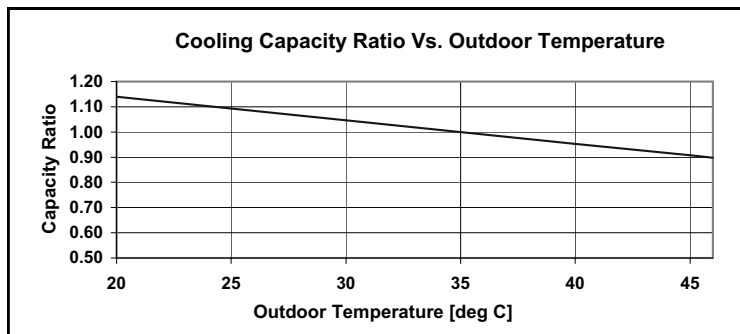

5.3.3 Heating

OD COIL ENTERING AIR DB/WB TEMPERATURE [C°]	DATA	ID COIL ENTERING AIR DB TEMPERATURE [C°]		
		15	20	25
-15/-16	TC	4.84	4.50	4.16
	PI	1.25	1.38	1.50
-10/-12	TC	5.38	5.05	4.71
	PI	1.50	1.63	1.76
-7/-8	TC	5.80	5.46	5.12
	PI	1.70	1.82	1.95
-1/-2	TC	6.00	5.66	5.32
	PI	1.79	1.92	2.05
2/1	TC	6.14	5.80	5.46
	PI	1.86	1.98	2.11
7/6	TC	7.94	7.60	7.26
	PI	1.95	2.08	2.21
10/9	TC	8.38	8.04	7.70
	PI	2.07	2.20	2.32
15/12	TC	8.81	8.48	8.14
	PI	2.19	2.31	2.44
15-24 (Protection Range)	TC	85 - 105 % of nominal		
	PI	80 - 120 % of nominal		

LEGEND

- TH – Total Heating Capacity, kW
- PI – Power Input, kW
- WB – Wet Bulb Temp., (°C)
- DB – Dry Bulb Temp., (°C)
- ID – Indoor
- OD – Outdoor

5.3.4 Capacity Correction Factors (Heating)

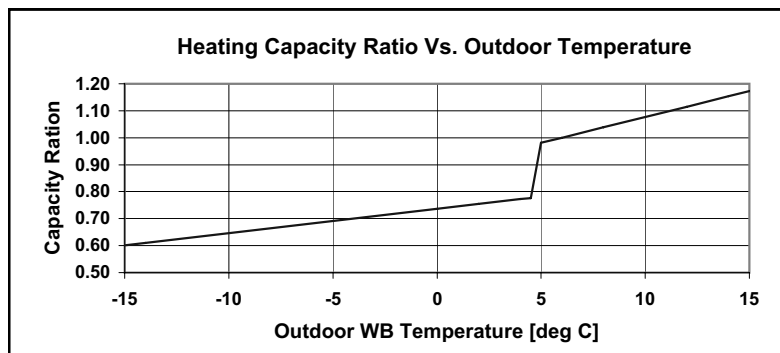

5.3.5 Pressure Curves (Cooling – Test Mode)

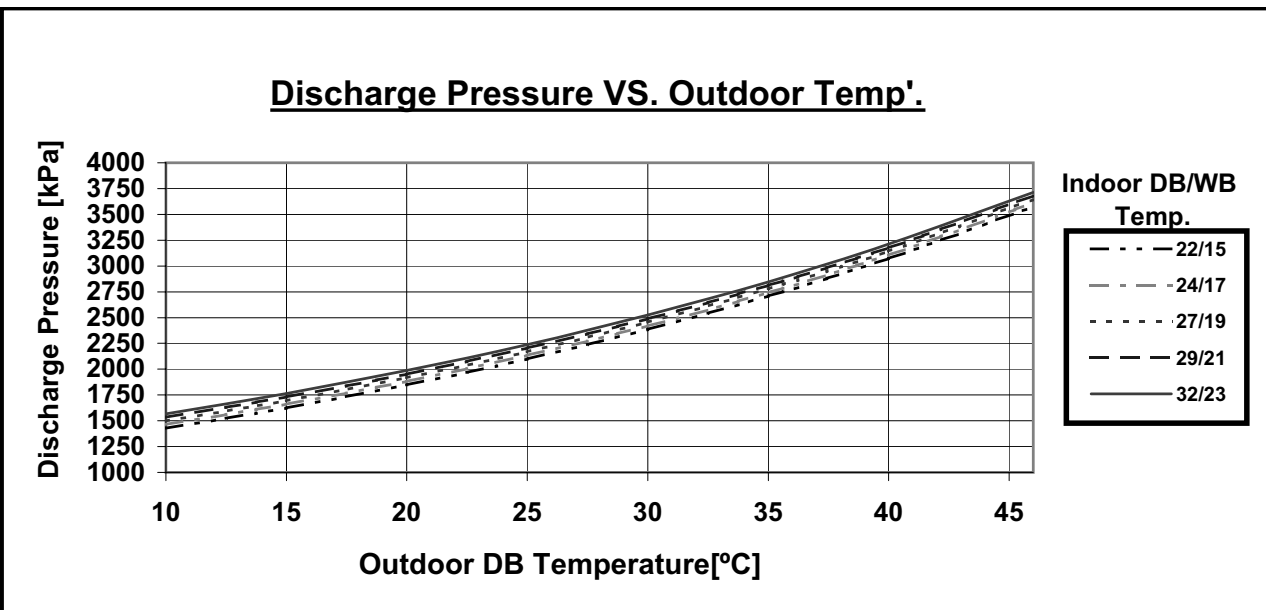
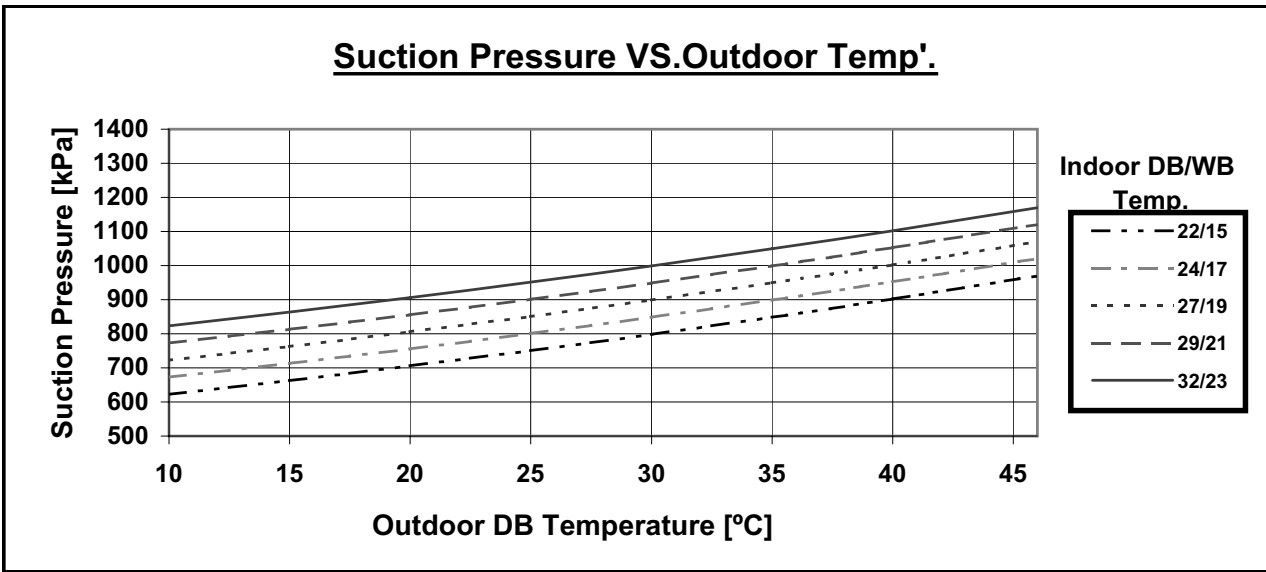

5.3.6 Pressure Curves (Heating – Test Mode)

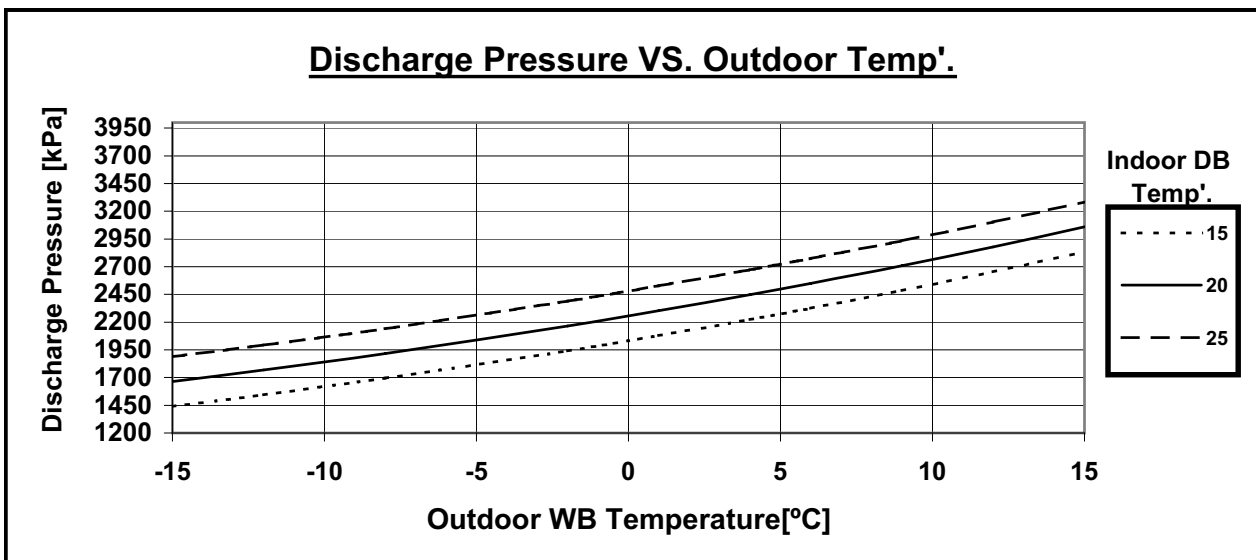
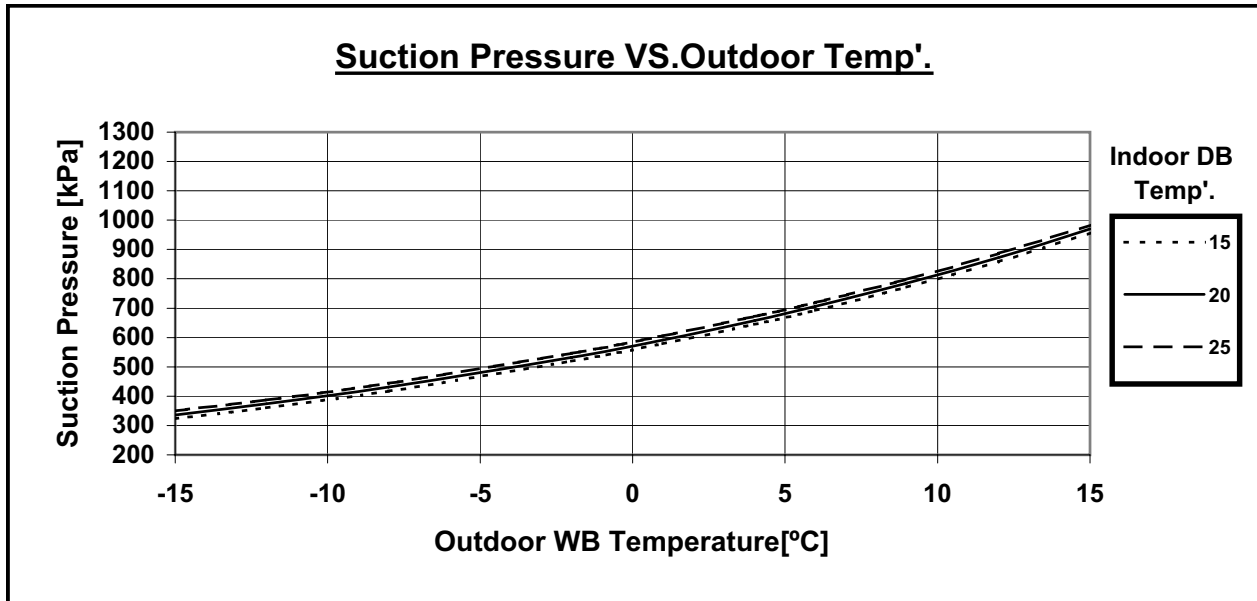

5.3.7 Capacity Correction Factor Due to Tubing Length
Cooling

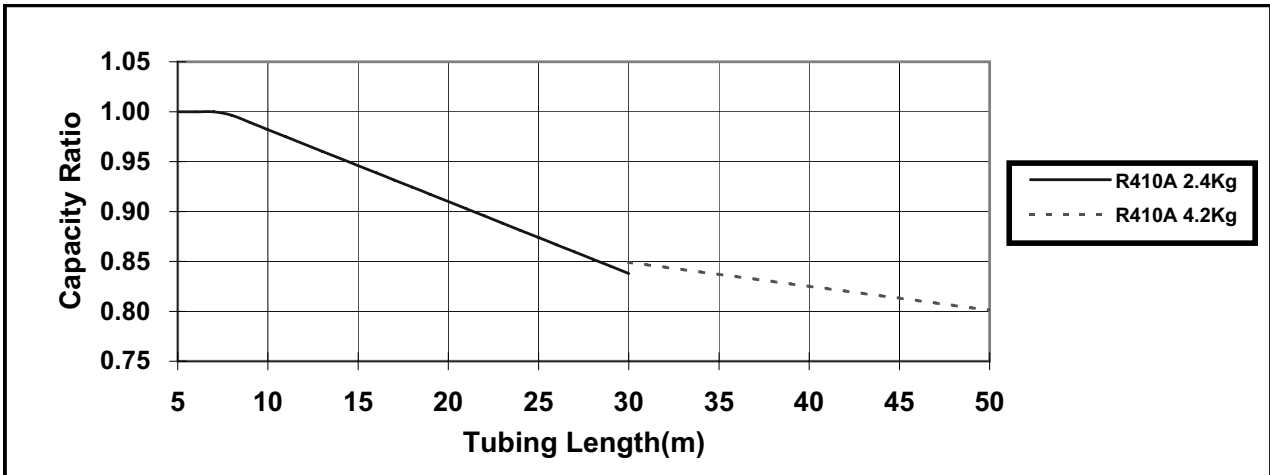

Heating

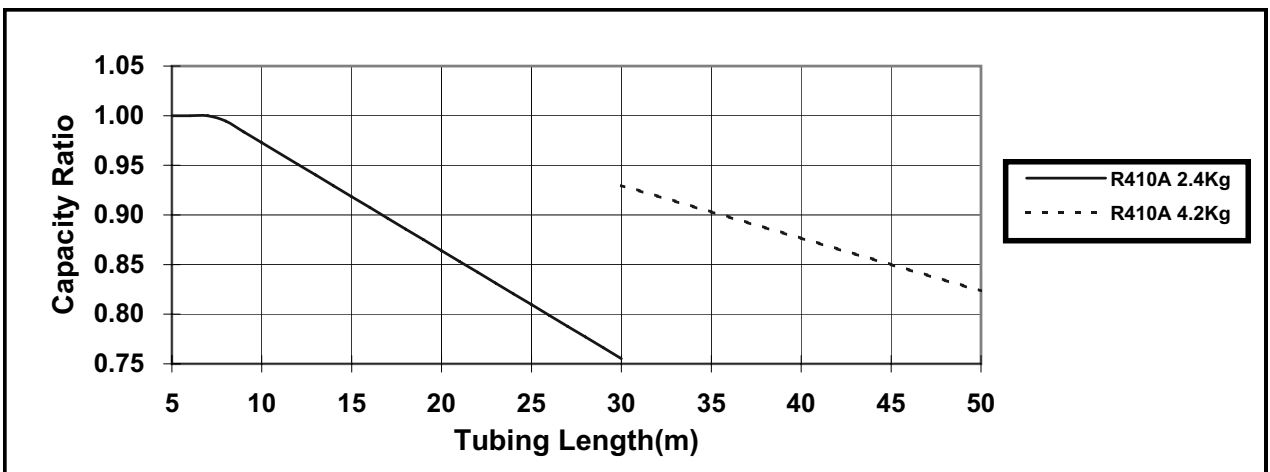

5.4 DNG80 DCI / DCI 80

5.4.1 Cooling Capacity (kW)

OD COIL ENTERING AIR DB TEMPERATURE [C°]		ID COIL ENTERING AIR DB/WB TEMPERATURE [C°]				
		22/15	24/17	27/19	29/21	32/23
-10 - 20 (protection range)	TC	80 - 110 % of nominal				
	SC	80 - 105 % of nominal				
	PI	25 - 50 % of nominal				
25	TC	7.25	7.72	8.20	8.67	9.15
	SC	6.01	6.13	6.25	6.38	6.50
	PI	1.95	1.99	2.02	2.06	2.10
30	TC	6.90	7.37	7.85	8.32	8.80
	SC	5.86	5.98	6.10	6.22	6.35
	PI	2.18	2.21	2.25	2.29	2.33
35	TC	6.55	7.03	7.50	7.97	8.45
	SC	5.70	5.83	5.95	6.07	6.20
	PI	2.41	2.44	2.48	2.52	2.55
40	TC	6.20	6.68	7.15	7.63	8.10
	SC	5.55	5.68	5.80	5.92	6.04
	PI	2.63	2.67	2.71	2.75	2.78
46	TC	5.78	6.26	6.73	7.21	7.68
	SC	5.37	5.49	5.62	5.74	5.86
	PI	2.91	2.94	2.98	3.02	3.06

LEGEND

- TC – Total Cooling Capacity, kW
- SC – Sensible Capacity, kW
- PI – Power Input, kW
- WB – Wet Bulb Temp., (°C)
- DB – Dry Bulb Temp., (°C)
- ID – Indoor
- OD – Outdoor

5.4.2 Capacity Correction Factors (Cooling)

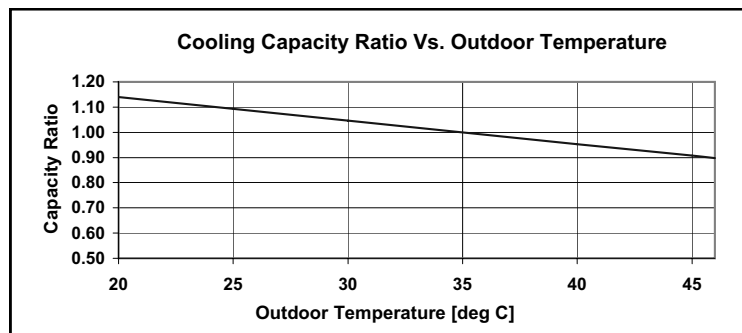

5.4.3 Heating

		ID COIL ENTERING AIR DB TEMPERATURE [C°]		
OD COIL ENTERING AIR DB/WB TEMPERATURE [C°]	DATA	15	20	25
-15/-16	TH	5.60	5.21	4.82
	PI	1.46	1.61	1.76
-10/-12	TH	6.23	5.84	5.45
	PI	1.77	1.91	2.06
-7/-8	TH	6.71	6.32	5.93
	PI	1.99	2.14	2.29
-1/-2	TH	6.95	6.56	6.16
	PI	2.10	2.25	2.40
2/1	TH	7.11	6.71	6.32
	PI	2.18	2.33	2.48
7/6	TH	9.19	8.80	8.41
	PI	2.29	2.44	2.59
10/9	TH	9.70	9.31	8.92
	PI	2.43	2.58	2.73
15/12	TH	10.21	9.81	9.42
	PI	2.57	2.71	2.86
15-24 (Protection Range)	TH	85 - 105 % of nominal		
	PI	80 - 120 % of nominal		

LEGEND

- TH – Total Heating Capacity, kW
- PI – Power Input, kW
- WB – Wet Bulb Temp., (°C)
- DB – Dry Bulb Temp., (°C)
- ID – Indoor
- OD – Outdoor

5.4.4 Capacity Correction Factors (Heating)

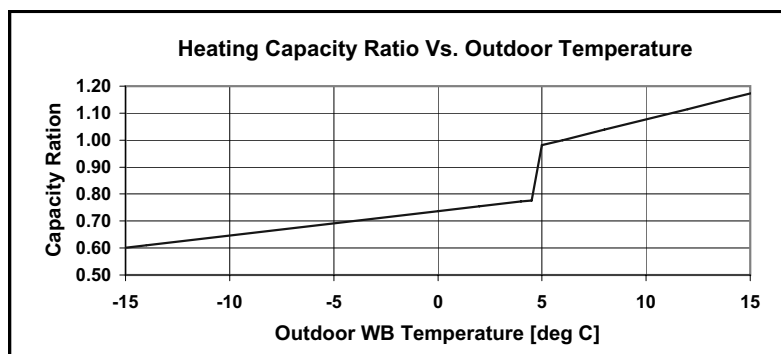

5.4.5 Pressure Curves (Cooling – Test Mode)

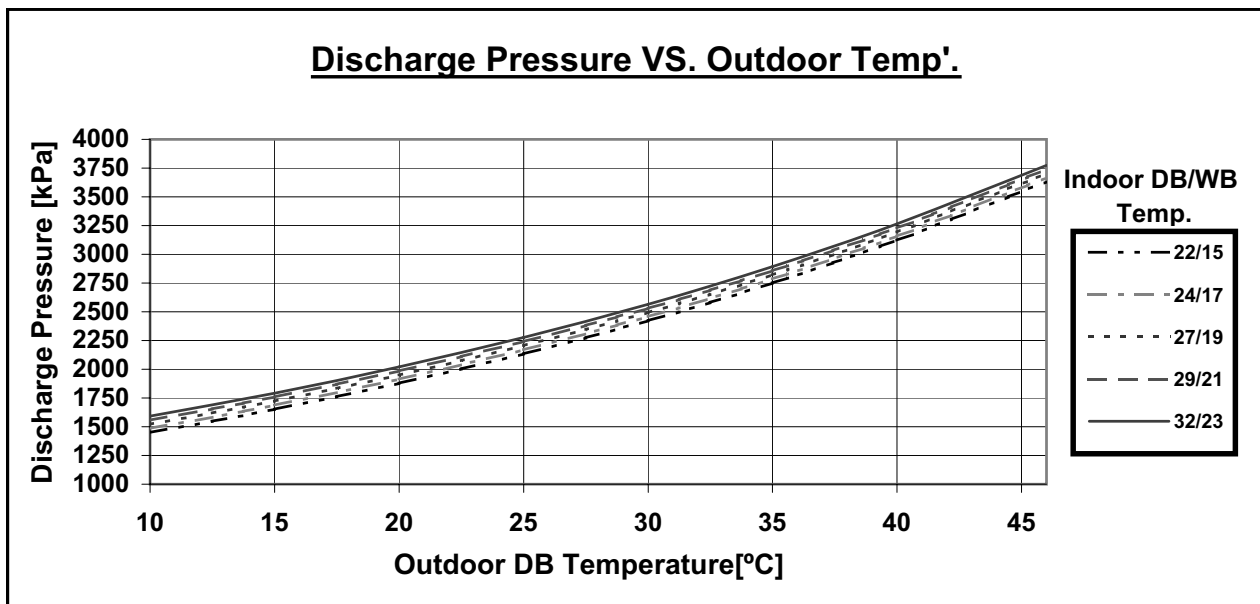
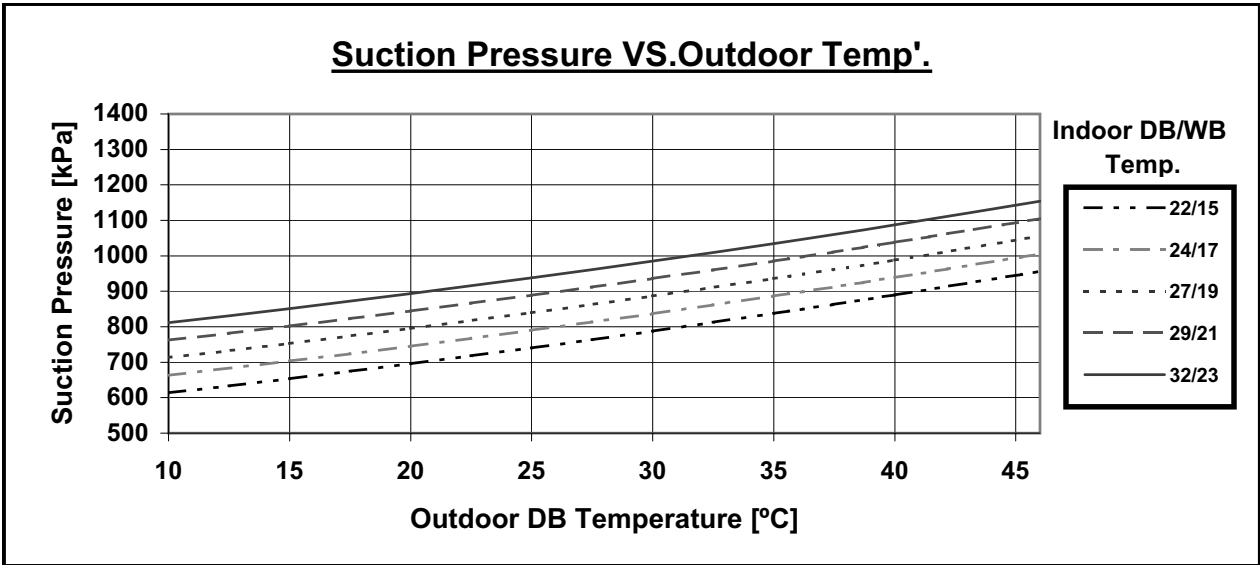

5.4.6 Pressure Curves (Heating – Test Mode)

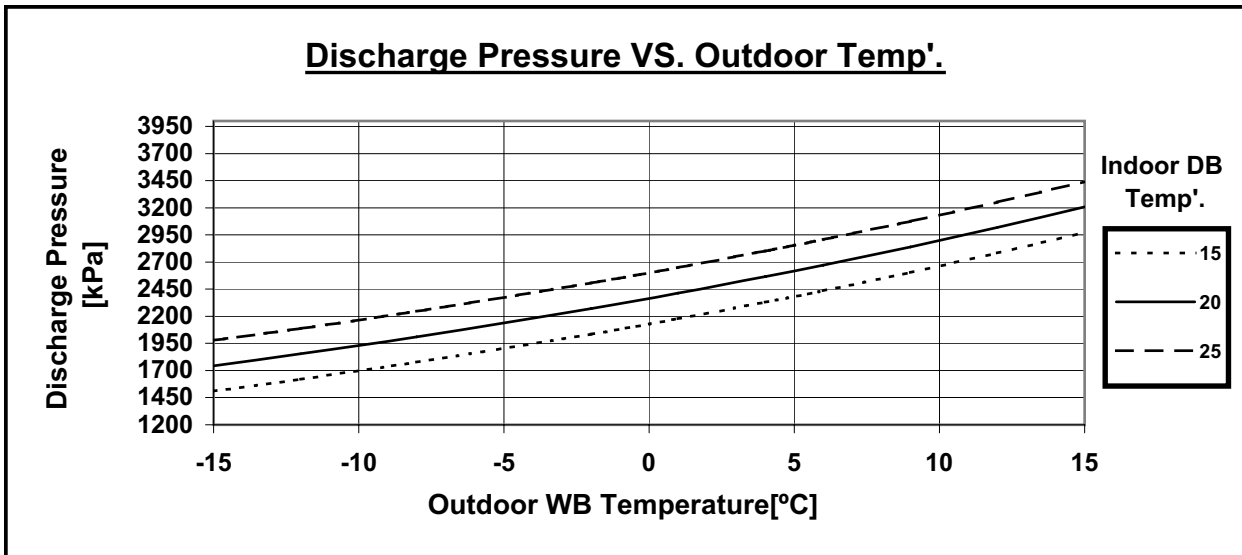
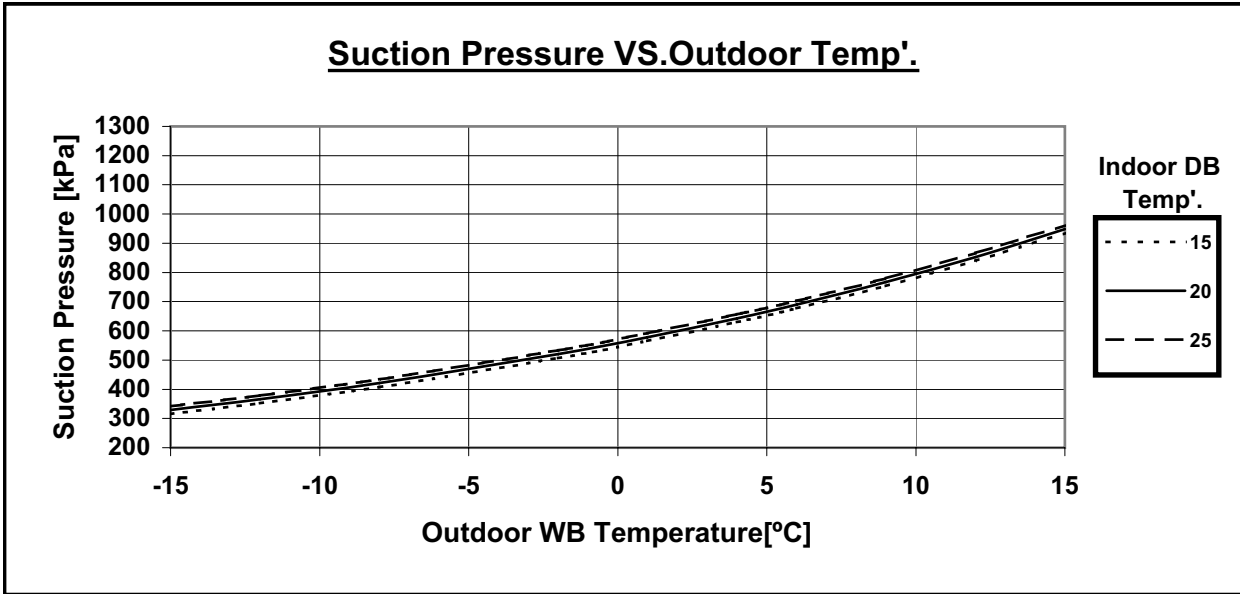

5.4.7 Capacity Correction Factor Due to Tubing Length Cooling

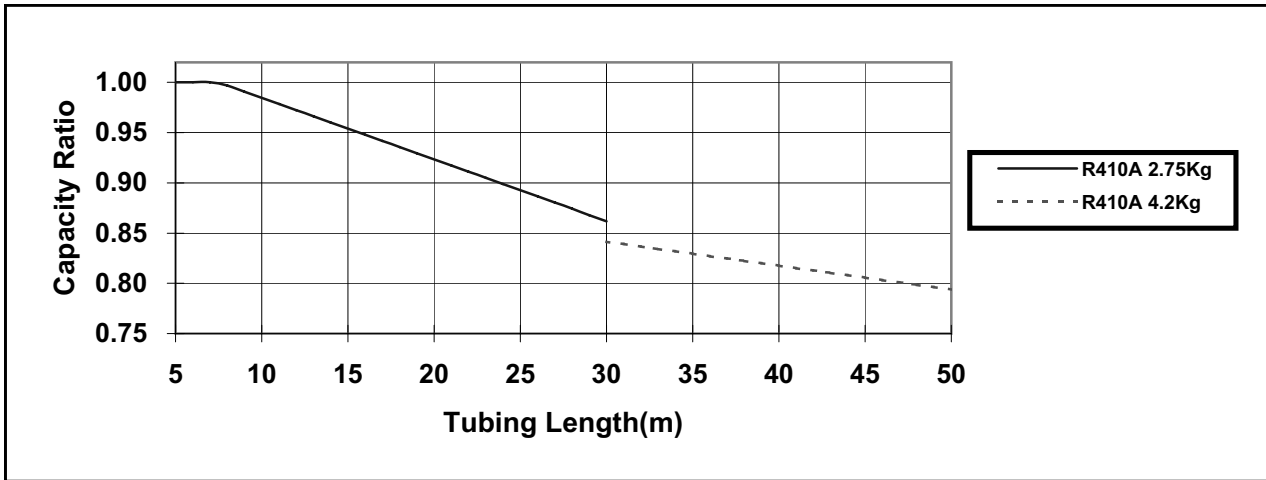

Heating

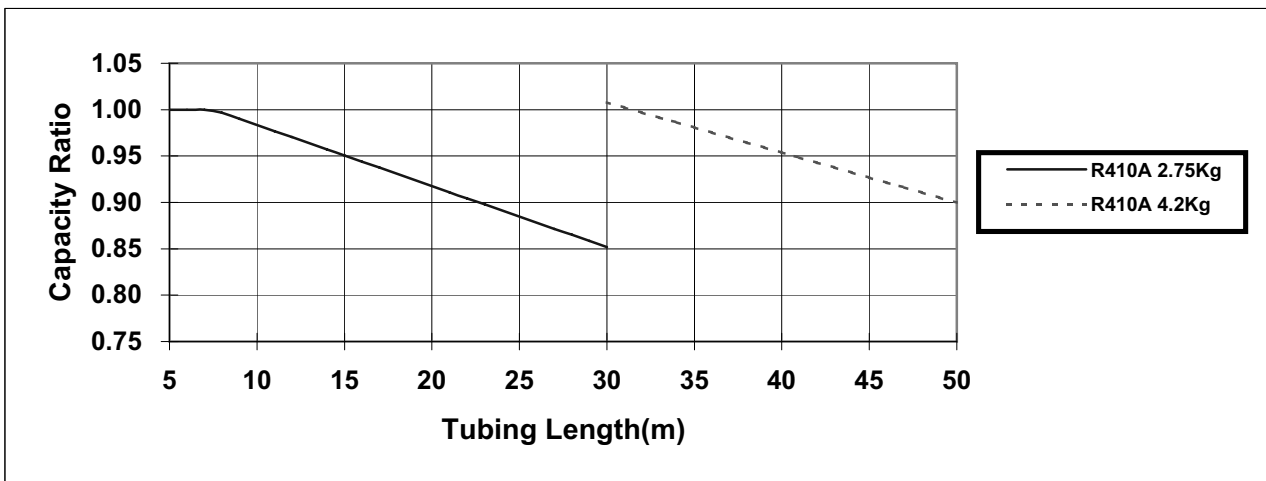

6. AIRFLOW CURVES

6.1 Model: DNG 50 DCI

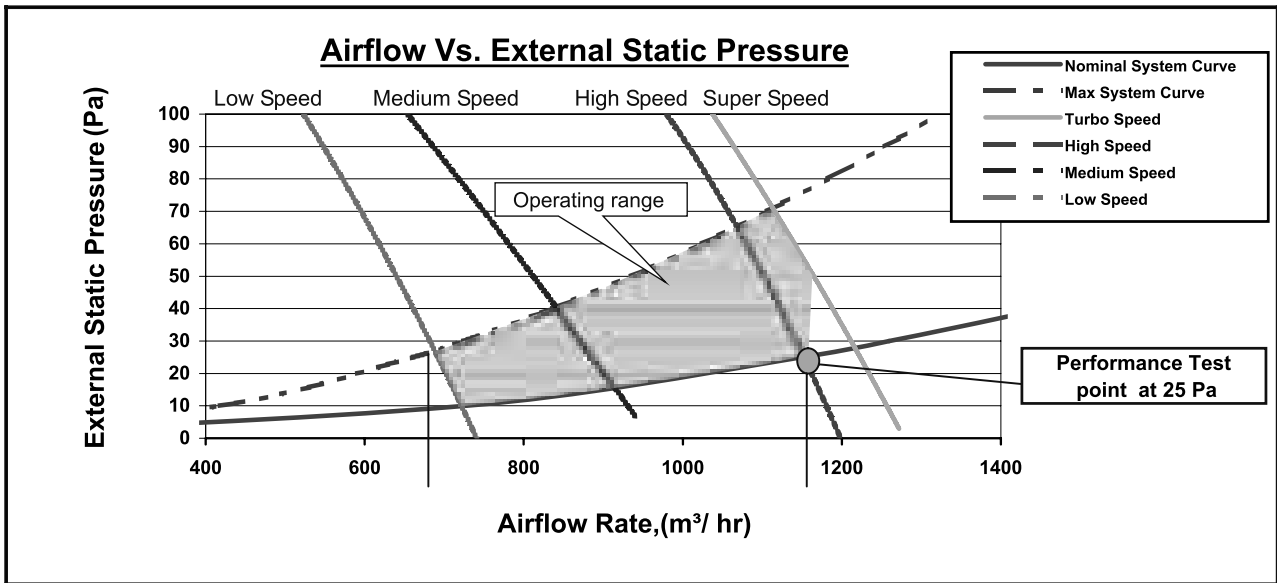

6.2 Model: DNG 60 DCI

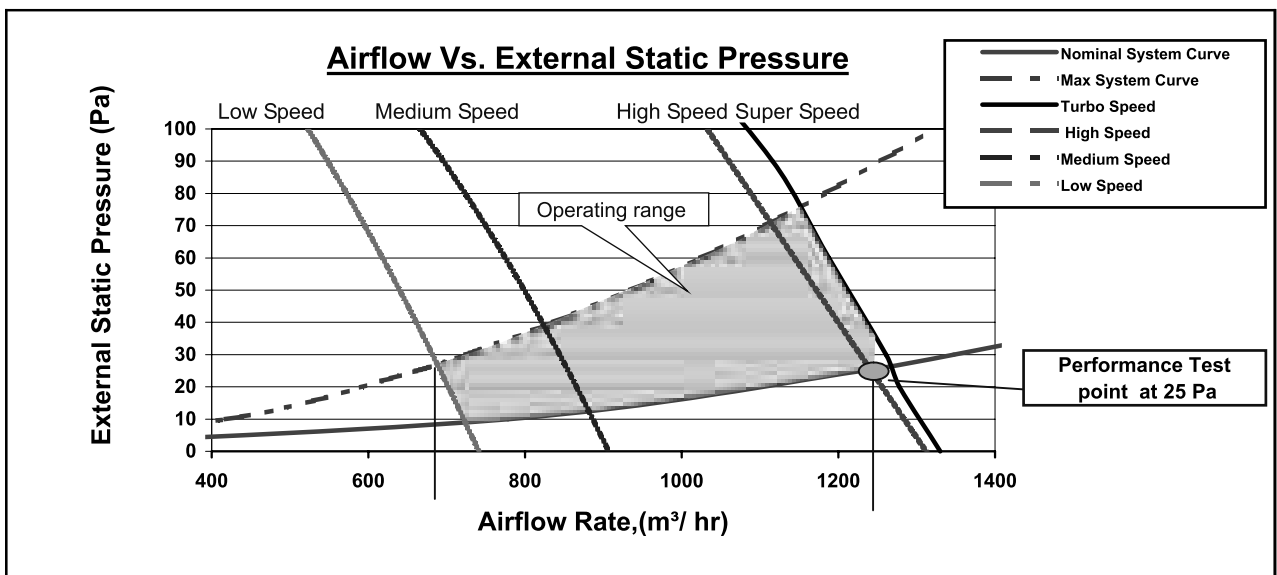

6.3 Model: DNG 72 DCI

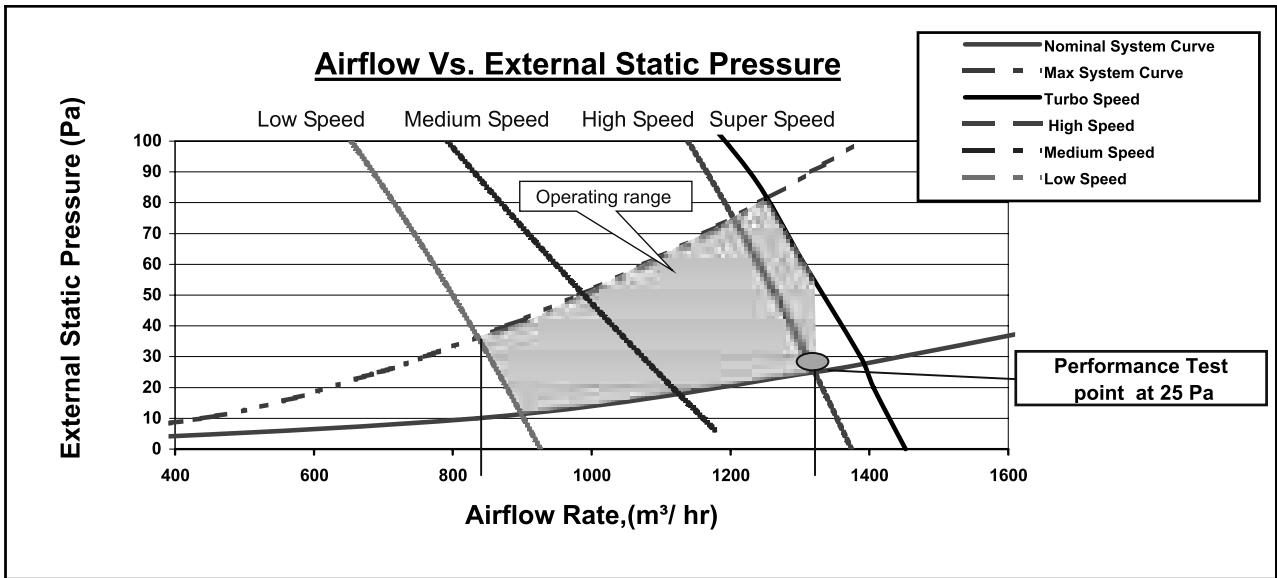

6.4 Model: DNG 80 DCI

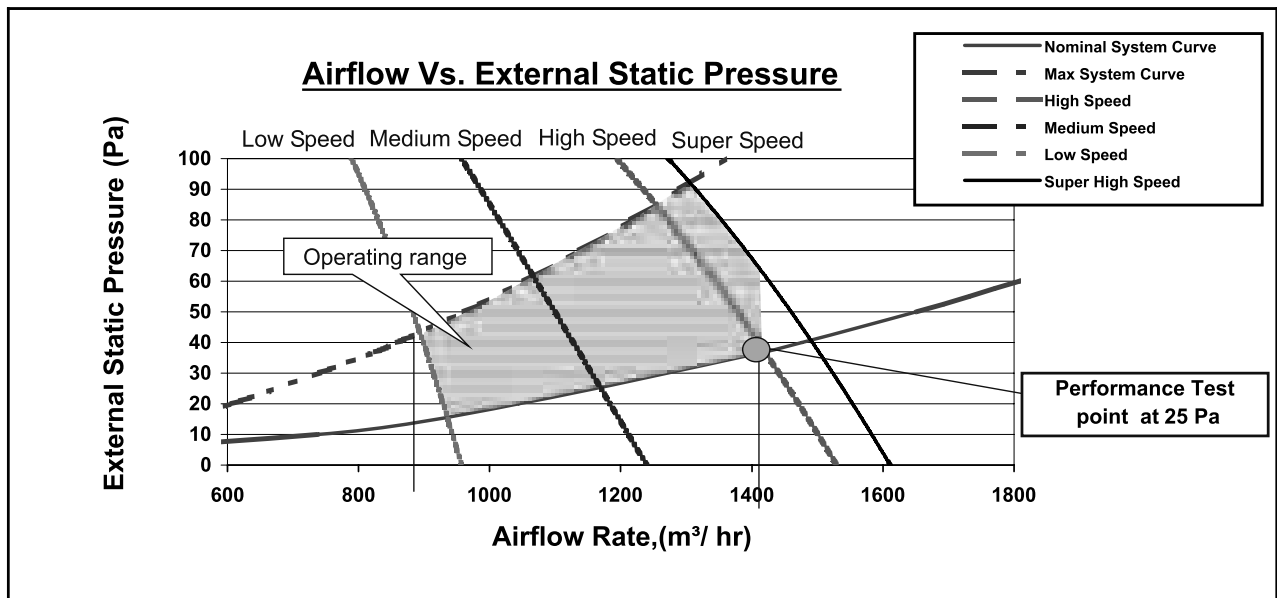

6.5 DNG UNITS RANGE AIR FLOW CORRECTION FACTORS
 (at nominal rating conditions — Test mode).

		Air Flow Rate [% of nominal]				
		60%	70%	80%	90%	100%
Cooling	TC	0.88	0.91	0.94	0.97	1
	SC	0.78	0.84	0.89	0.95	1
	PI	0.95	0.97	0.98	0.99	1
Heating	PI	1.07	1.05	1.03	1.02	1
	TC	0.90	0.92	0.95	0.97	1

* Permissible Air flow Rate - according to model Air Flow Curves

7. SOUND LEVEL CHARACTERISTICS

7.1 Sound Pressure Level

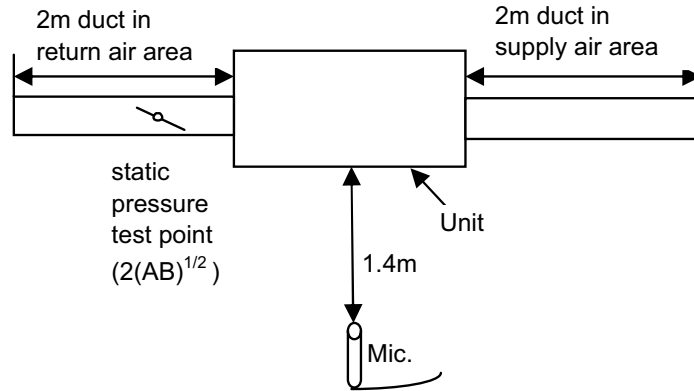
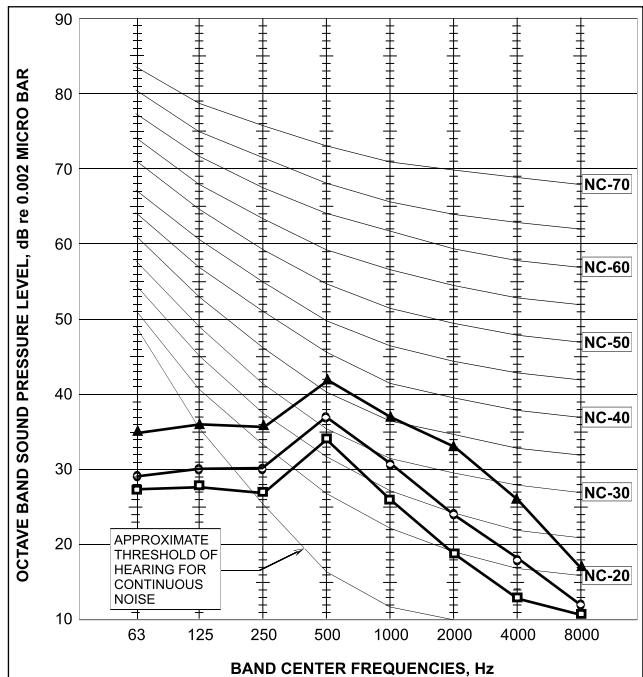
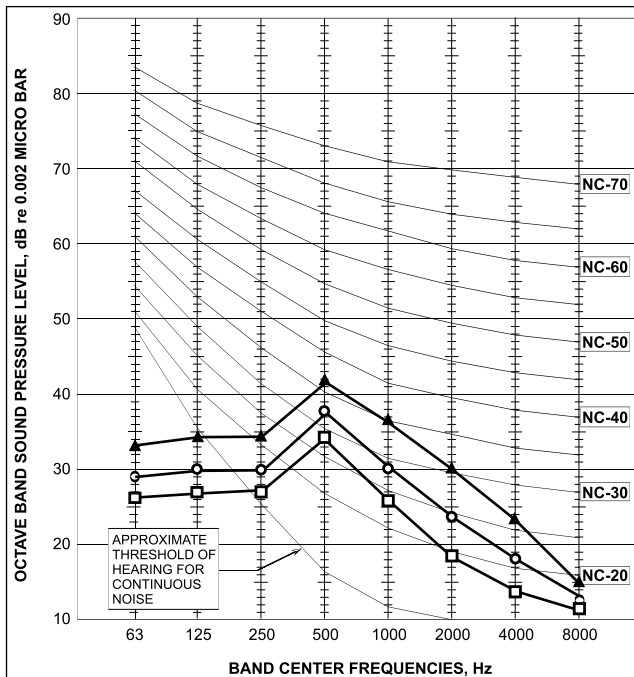

Figure 1

7.2 Sound Pressure Level Spectrum (Measured as Figure 1)

DNG 50

DNG 60



FAN SPEED	LINE
HI	—▲—
ME	—○—
LO	—□—

DNG 72

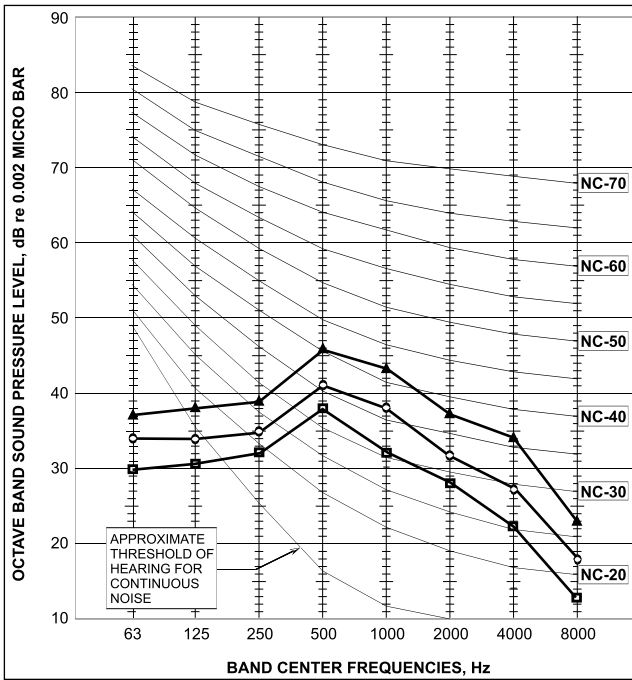

DNG 80

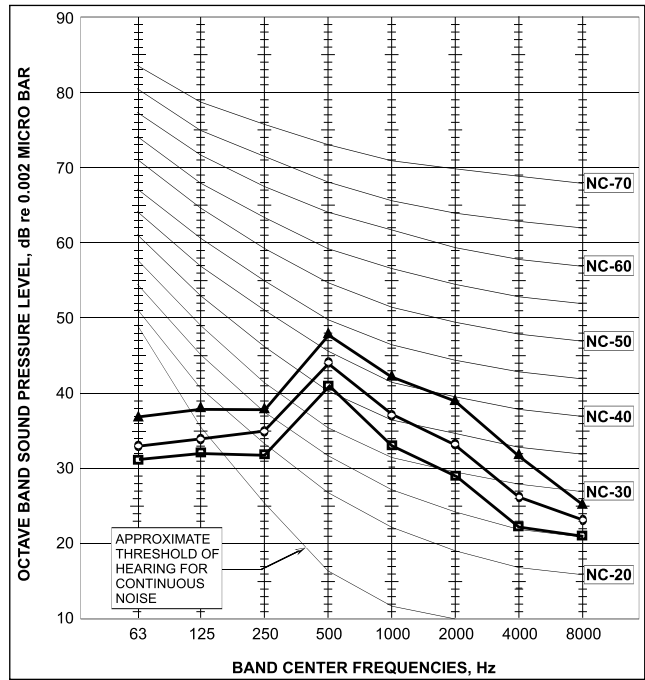

FAN SPEED	LINE
HI	—▲—
ME	—○—
LO	—□—

7.3 Outdoor units

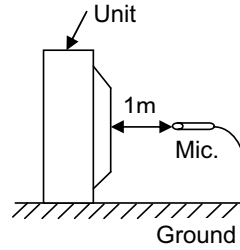
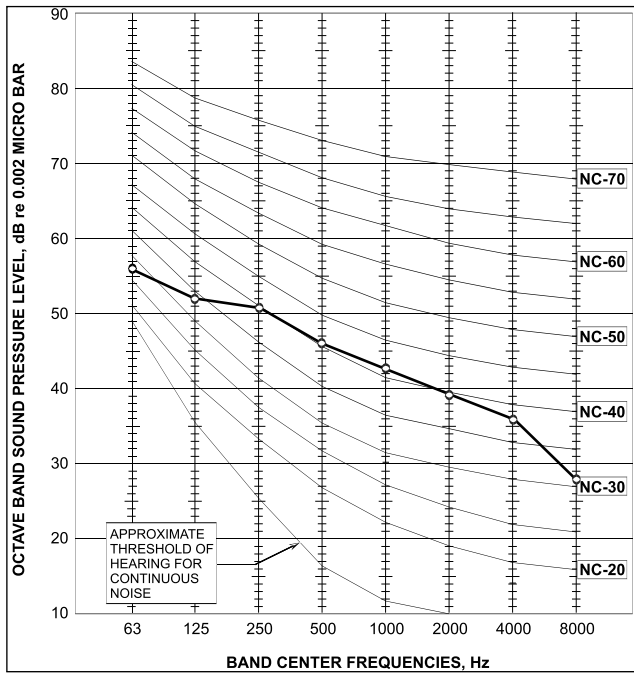

Figure 2

7.4 Sound Pressure Level Spectrum (Measured as Figure 2)

DCI 50 Cooling



DCI 50 Heating

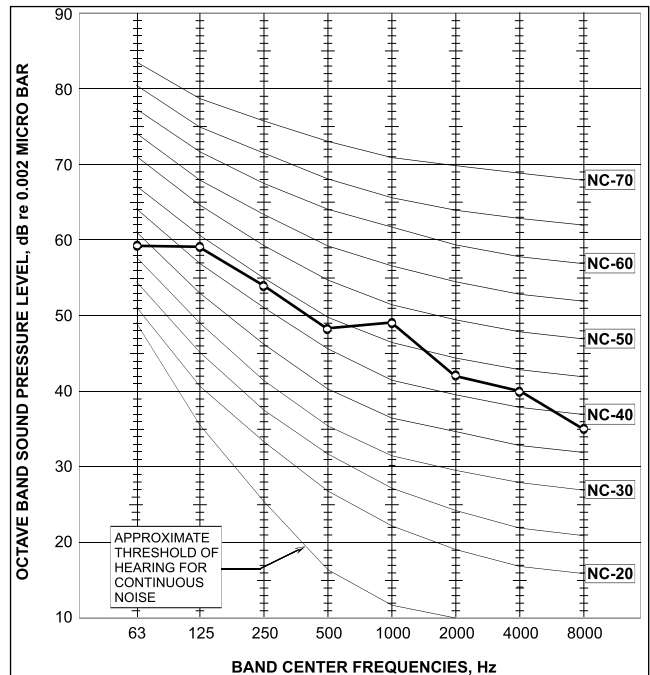

DCI 60 Cooling

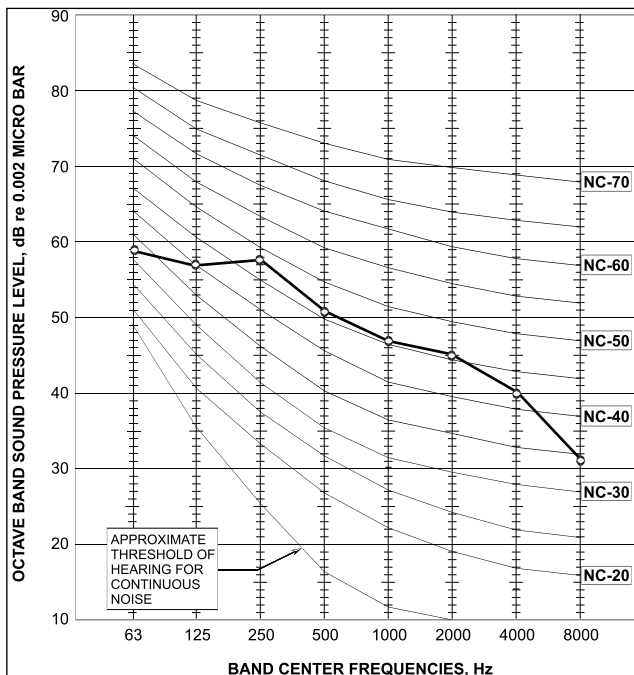

DCI 60 Heating

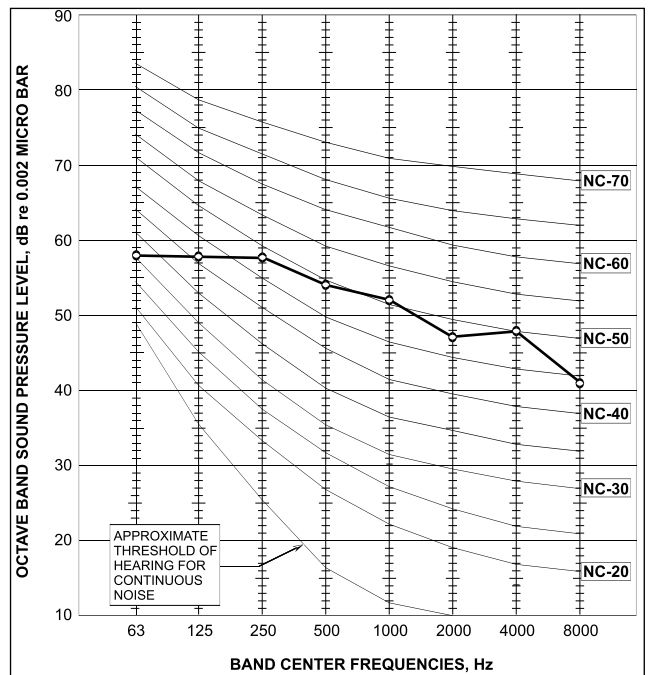

DCI 72 Cooling

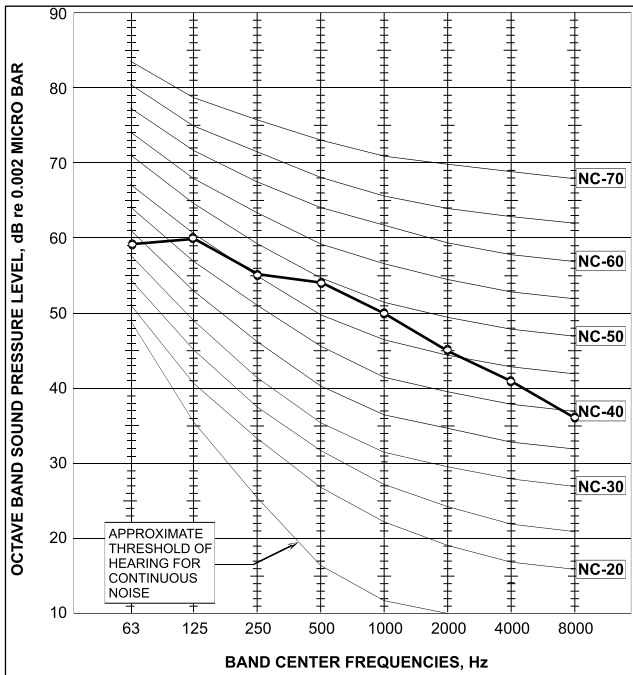

DCI 72 Heating

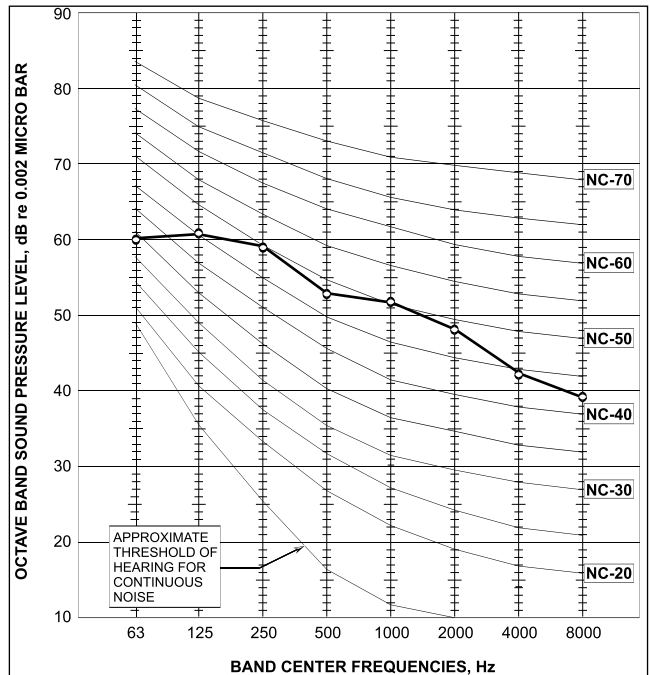

DCI 72Z Cooling

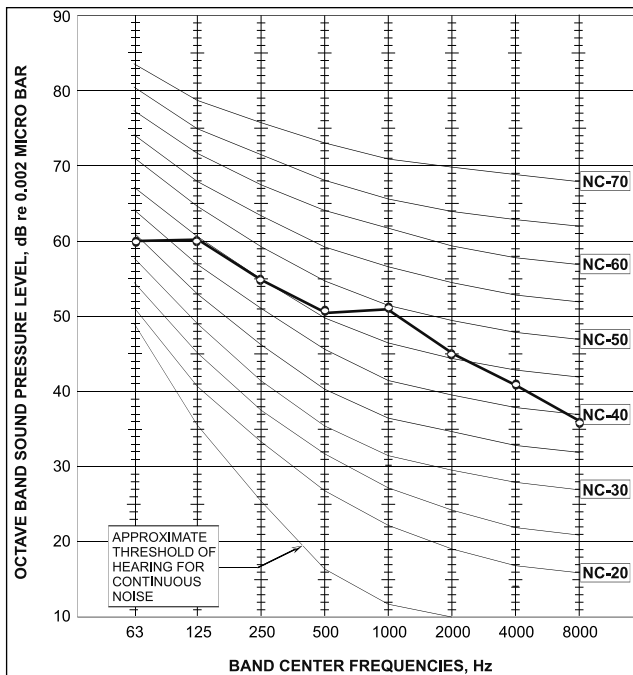

DCI 72Z Heating

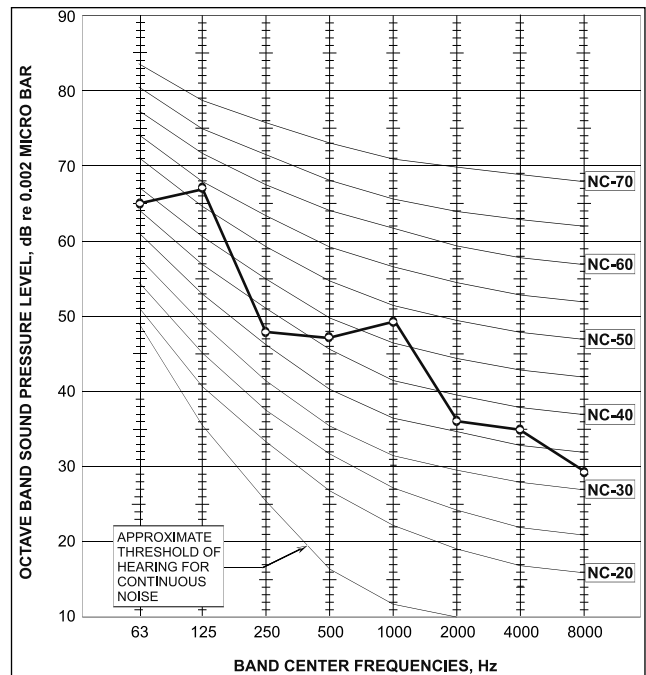

DCI 80 Cooling

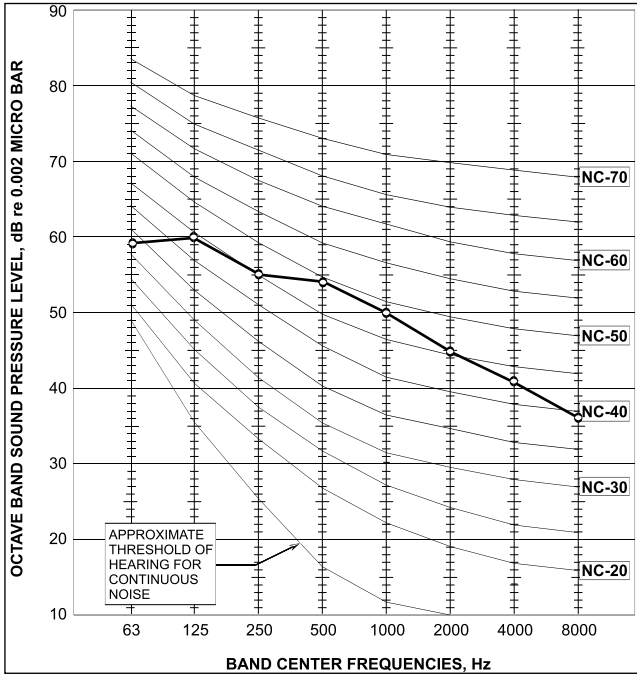

DCI 80 Heating

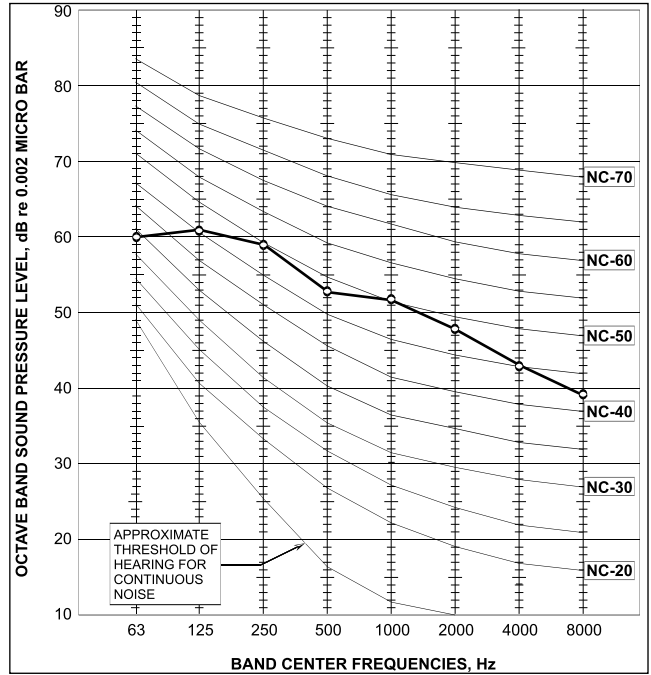

8. ELECTRICAL DATA

8.1 Single Phase Units

Model	DNG50	DNG60	DNG72	DNG80
Power Supply	1 PH ,220-240VAC ,50HZ			
Connected to	Indoor or Outdoor		Outdoor	
Maximum Current	15A	15A	15A	15A
Inrush Current	45 A			
Starting Current	15 A	15A	15A	15A
Circuit Breaker	20 A			
Power Supply Wiring no x cross section	3 X 2.5 mm ²			
Interconnecting cable no x cross section	4X 2.5 mm ²			

(a) Inrush current is the current when power is up (charging the DC capacitors at outdoor unit controller).

(b) Starting current is the current when starting the compressor.

NOTE:

Power wiring cord should comply with local laws and electrical regulations requirements.

9. WIRING DIAGRAMS

9.1 Indoor Unit: DNG 50 DCI

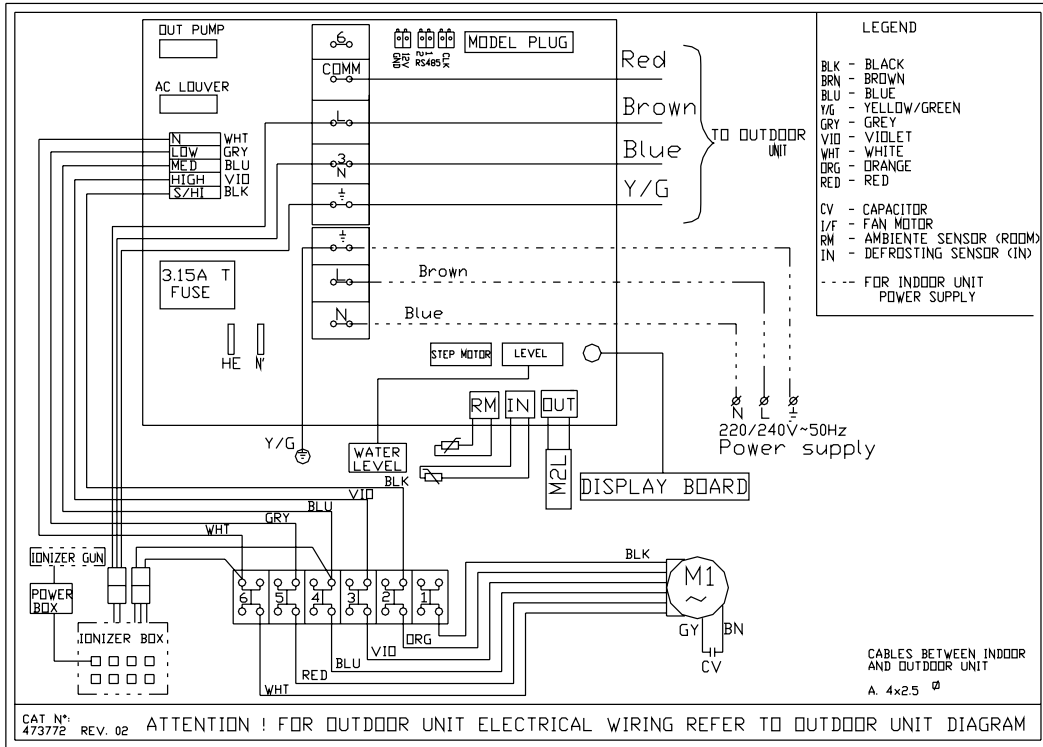

9.2 Indoor Unit: DNG 60 DCI

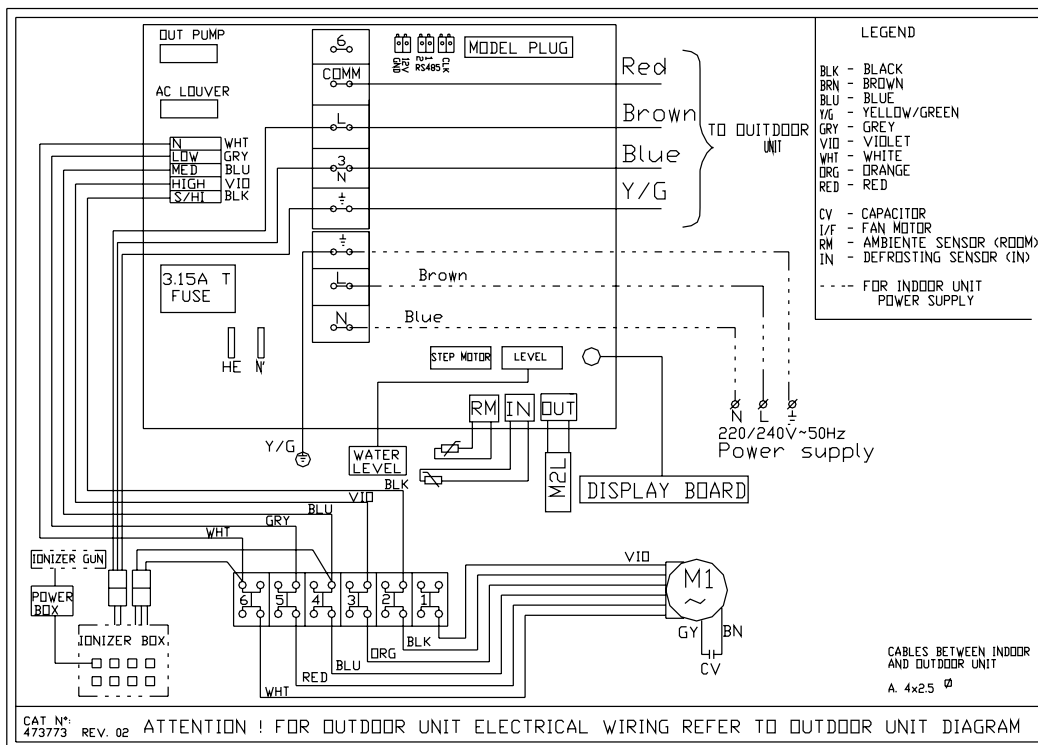

9.3 Indoor Unit: DNG 72/80 DCI

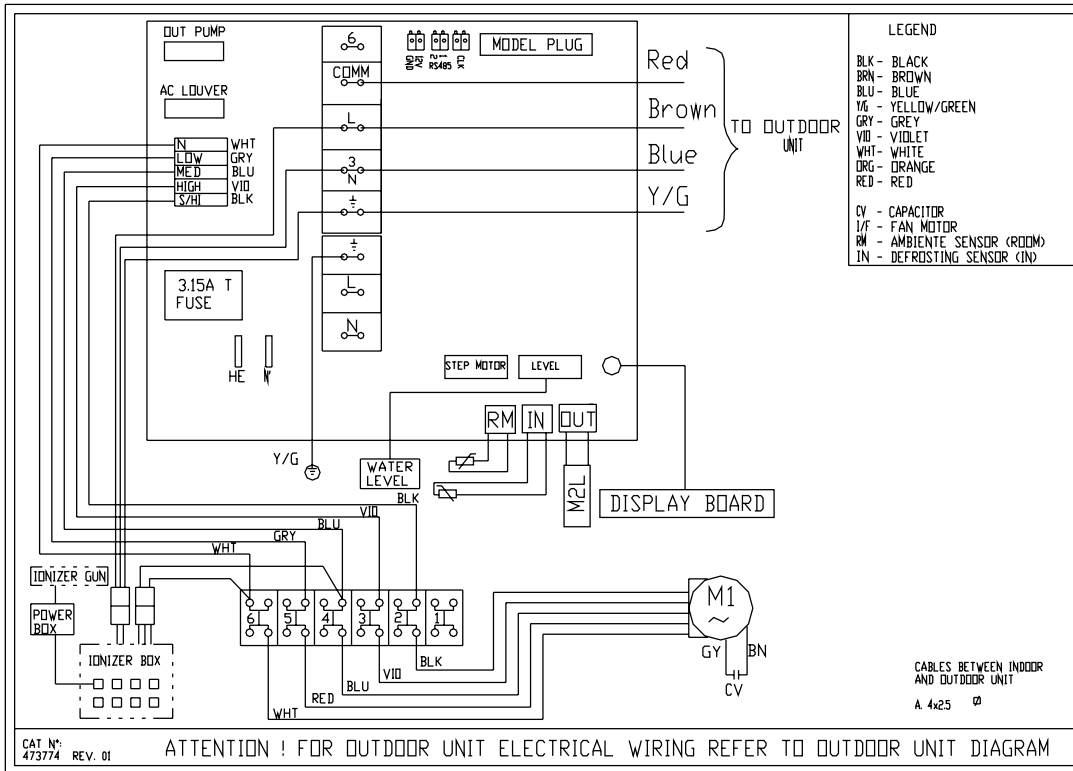

9.4 Outdoor Unit: DCI 50/60

9.4.1 DCI 50/60 for Indoor Power Supply

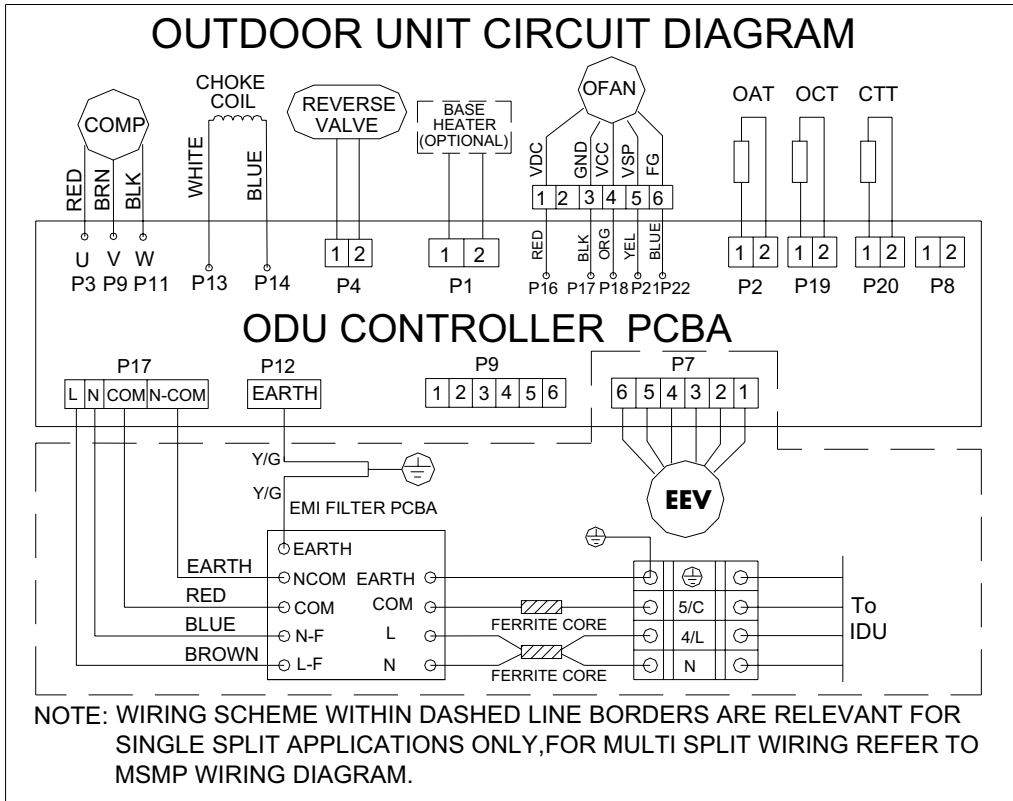

9.4.2 DCI 50/60 for Outdoor Power Supply

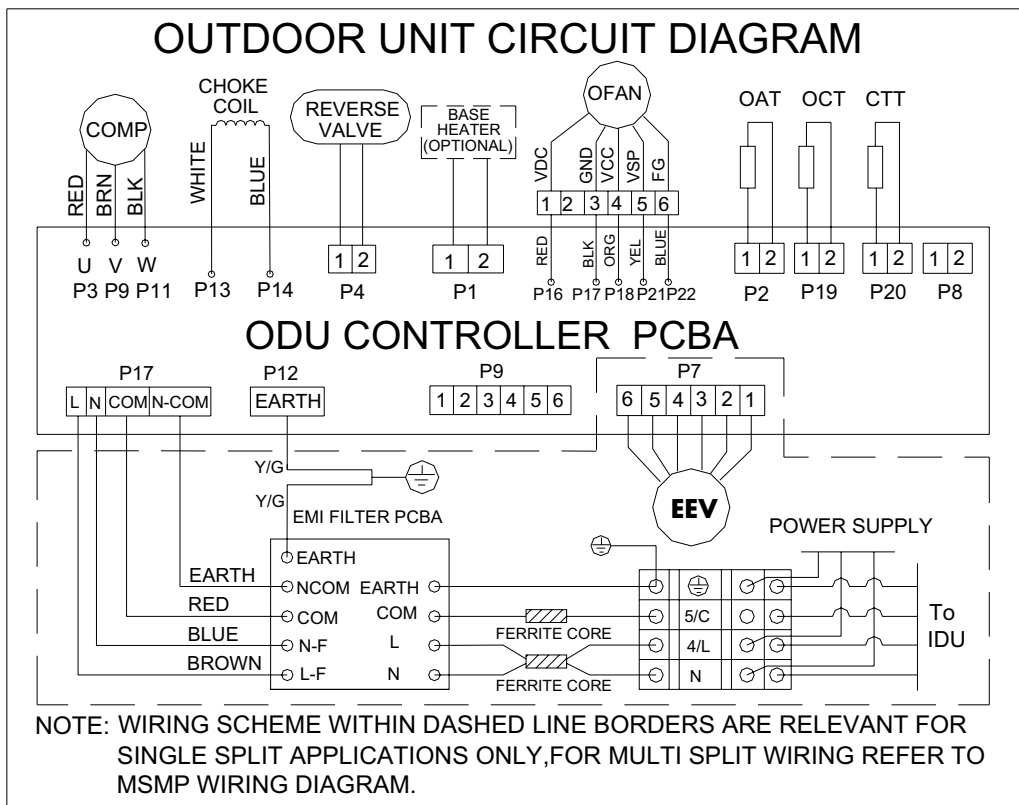

9.5 Outdoor Unit: DCI 72Z

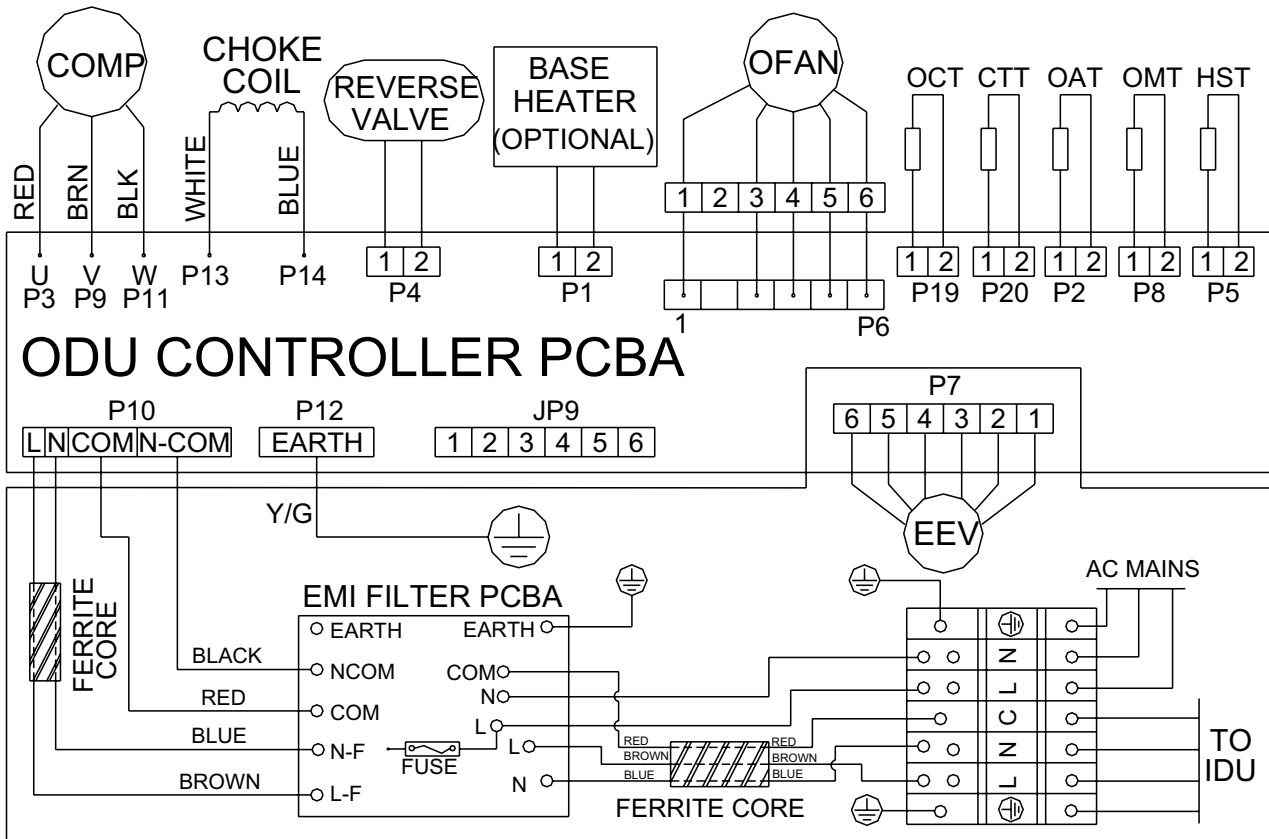

9.6 Outdoor Unit: DCI 72/80

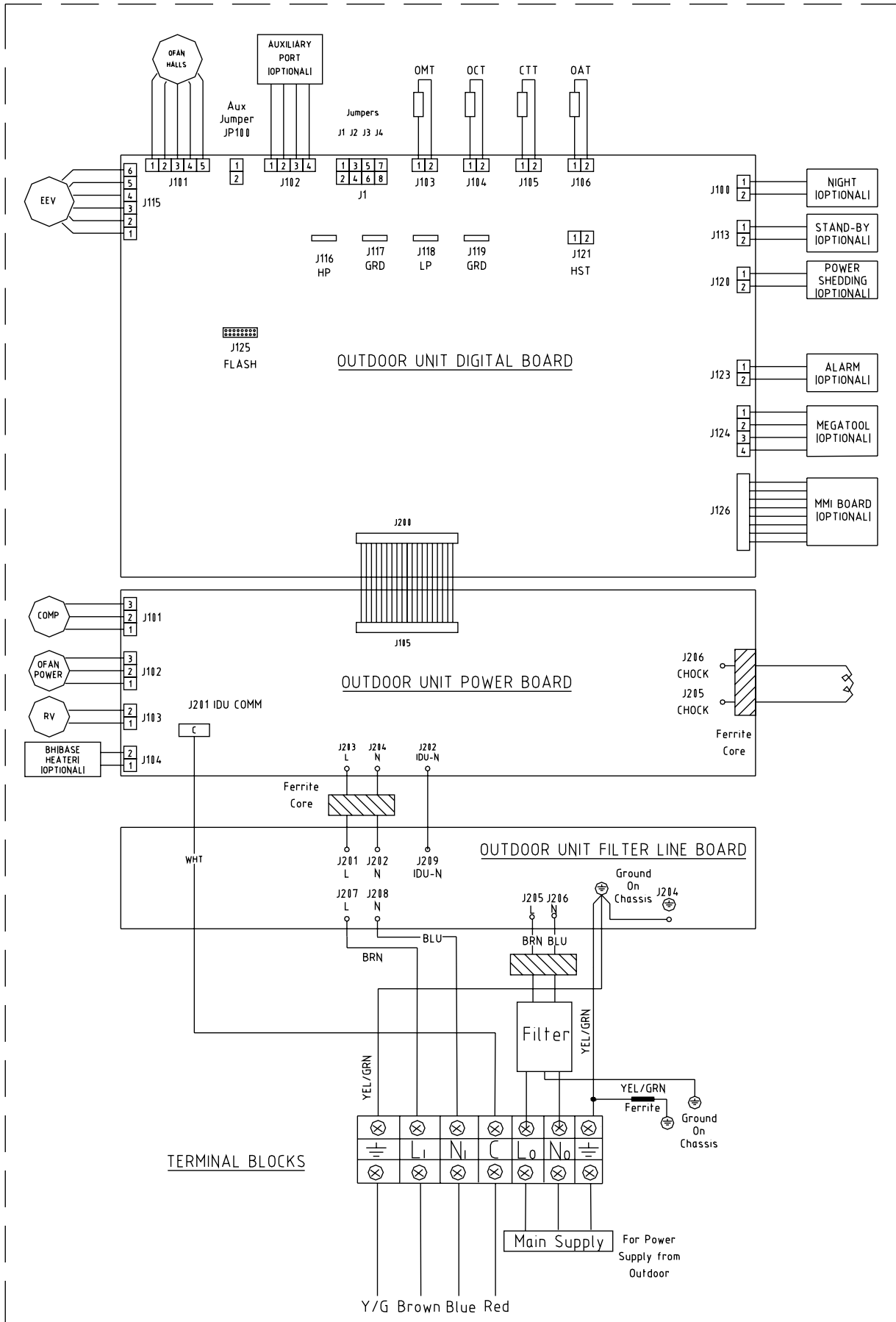

10. REFRIGERATION DIAGRAMS

10.1 Heat Pump Models

10.1.1 DNG 50/60/72/80

Cooling mode

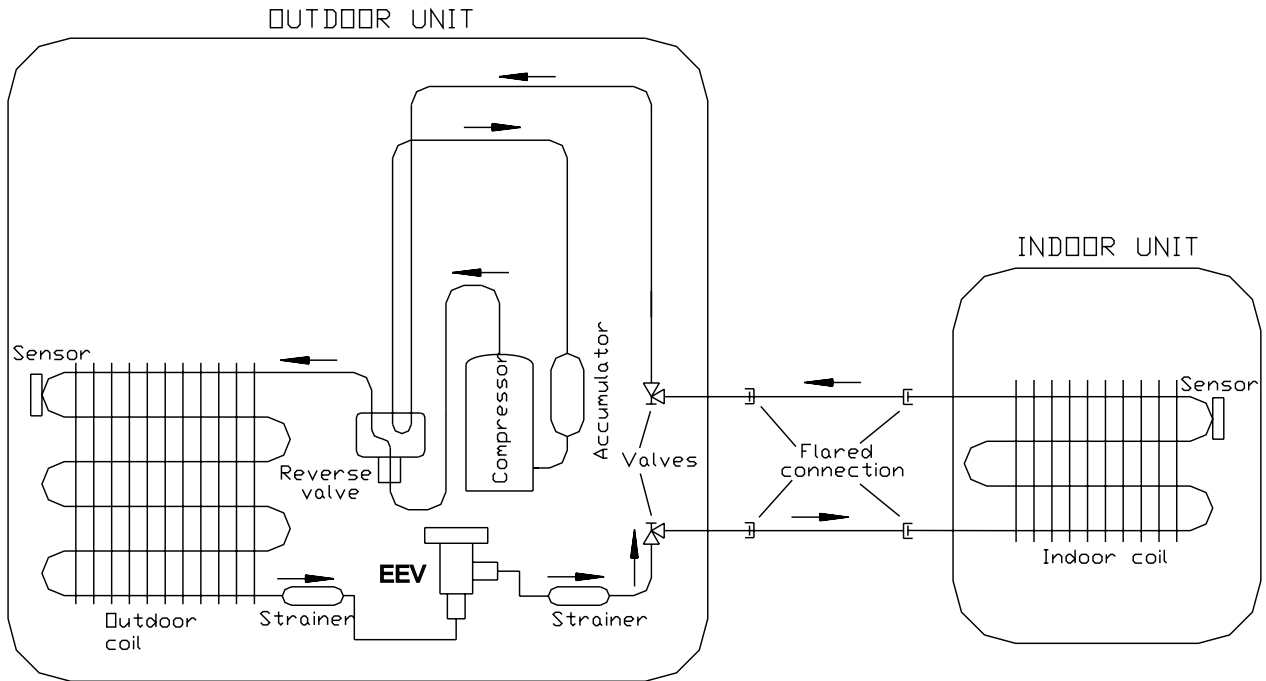

COOLING & DRY MODE

Heating mode

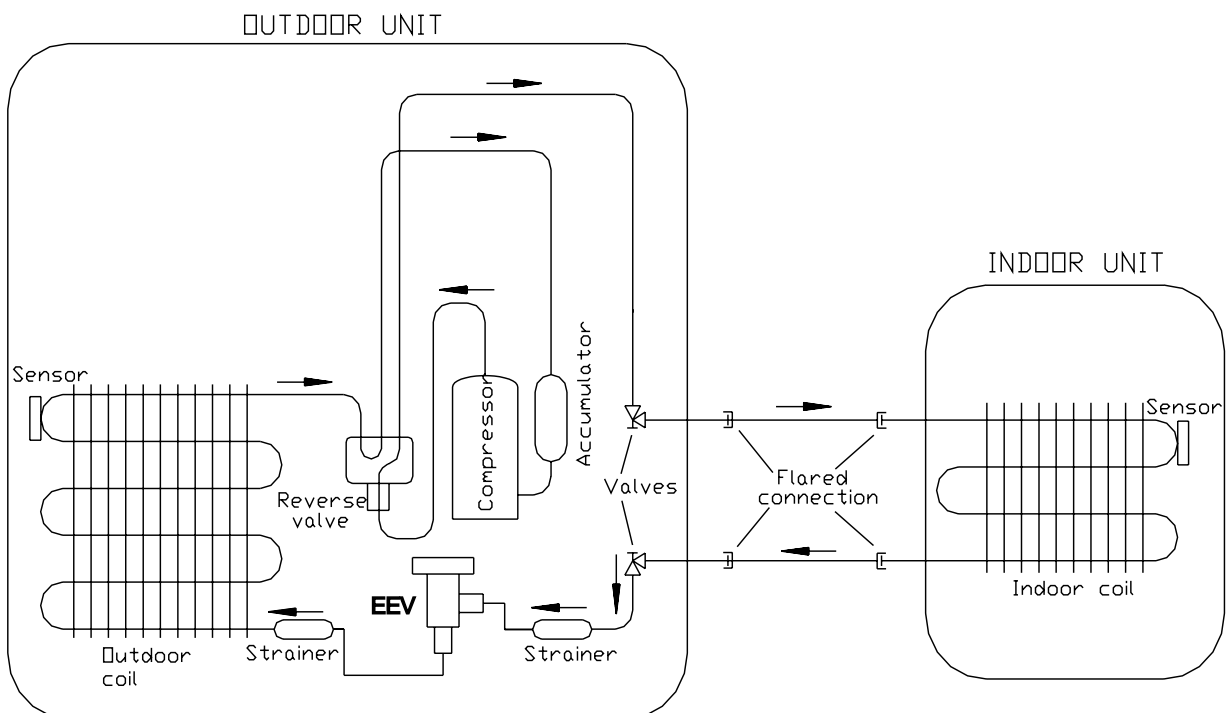

HEATING MODE

11. TUBING CONNECTIONS

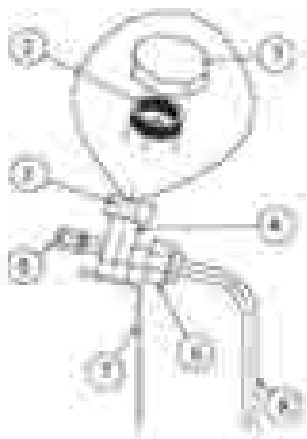
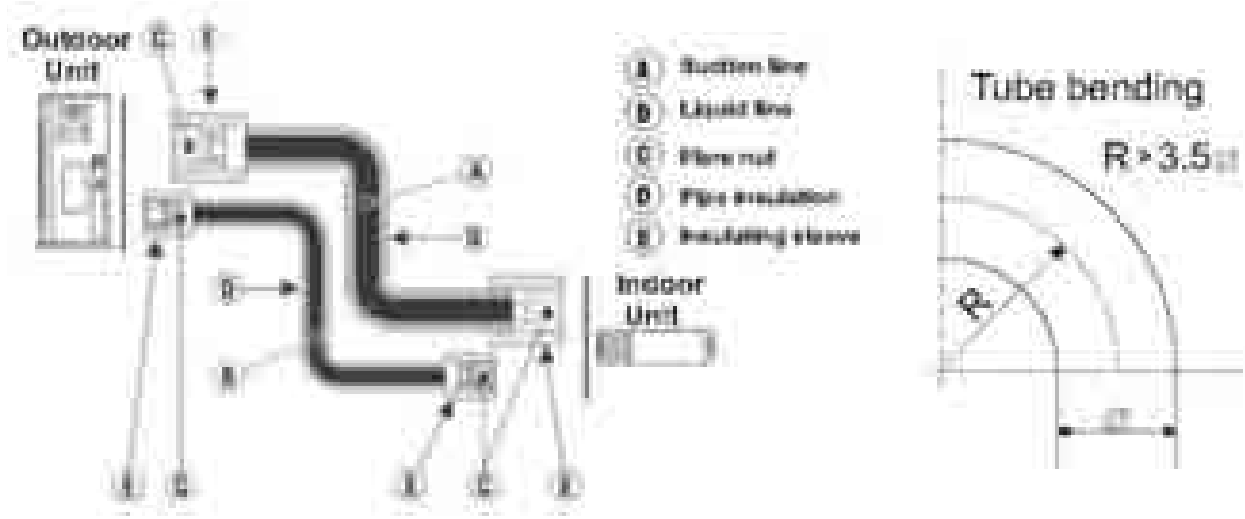

TUBE (Inch)	1/4"	3/8"	1/2"	5/8"	3/4"
TORQUE (Nm)					
Flare Nuts	15-18	40-45	60-65	70-75	80-85
Valve Cap	13-20	13-20	18-25	18-25	40-50
Service Port Cap	11-13	11-13	11-13	11-13	11-13

1. Valve Protection Cap-end
2. Refrigerant Valve Port (use Allen wrench to open/close)
3. Valve Protection Cap
4. Refrigerant Valve
5. Service Port Cap
6. Flare Nut
7. Unit Back Side
8. Copper Tube

When the outdoor unit is installed above the indoor unit an oil trap is required every 5m along the suction line at the lowest point of the riser. In case the indoor unit is installed above the outdoor, no trap is required.

*Applicable for DNG18 only, for DNG24 – 44 oil traps are not required.

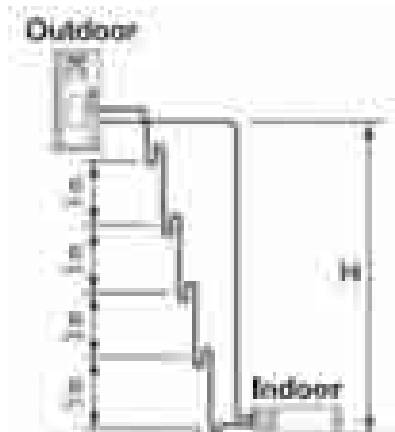

12. CONTROL SYSTEM

12.1 General Functions and Operating Rules

The DCI software is fully parametric.

All the model dependent parameters are shown in Blue color and with Italic style [*parameter*].

The parameters values are given in the last section of this control logic chapter of the service manual.

12.1.1 System Operation Concept

The control function is divided between indoor and outdoor unit controllers. Indoor unit is the system 'Master', requesting the outdoor unit for cooling/heating capacity supply. The outdoor unit is the system 'Slave' and it must supply the required capacity unless it enters into a protection mode avoiding it from supplying the requested capacity.

The capacity request is transferred via indoor to outdoor communication, and is represented by a parameter called 'NLOAD'. NLOAD is an integer number with values between 0 and 127, and it represents the heat or cool load felt by the indoor unit.

12.1.2 Compressor Frequency Control

12.1.2.1 NLOAD setting

The NLOAD setting is done by the indoor unit controller, based on a PI control scheme.

The actual NLOAD to be sent to the outdoor unit controller is based on the preliminary LOAD calculation, the indoor fan speed, and the power shedding function.

NLOAD limits as a function of indoor fan speed:

Indoor Fan Speed Maximum NLOAD Cooling Maximum NLOAD Heating

Indoor Fan Speed	Maxium NLOAD Cooling	Maxium NLOAD Heating
Low	<i>MaxNLOADIF1C</i>	<i>MaxNLOADIF1H</i>
Medium	<i>MaxNLOADIF2C</i>	<i>MaxNLOADIF2H</i>
High	<i>MaxNLOADIF3C</i>	<i>MaxNLOADIF3H</i>
Turbo	<i>MaxNLOADIF4C</i>	<i>MaxNLOADIF4H</i>
Auto	<i>MaxNLOADIF5C</i>	<i>MaxNLOADIF5H</i>

NLOAD limits as a function of power shedding:

Mode	Power Shedding OFF	Power Shedding ON
Cooling	No limit	Nominal Cooling
Heating	No limit	Nominal heating

12.1.3 Target Frequency Setting

12.1.3.1 Target Frequency Setting for DCI 50/60/72Z

The compressor target frequency is a function of the NLOAD number sent from the indoor controller and the outdoor air temperature.

Basic Target Frequency Setting:

NLOAD	Target Frequency
127	<i>Maximum Frequency</i>
10 < NLOAD < 127	Interpolated value between minimum and maximum frequency
10	Minimum frequency
0	Compressor is stopped

Target frequency limits as a function of outdoor air temperature (OAT):

OAT Range	Cooling Mode limits	Heating Mode limits
OAT < 6	<i>MaxFreqAsOATC</i>	No limit
6 ≤ OAT < 15		<i>MaxFreqAsOAT1H</i>
15 ≤ OAT < 28		<i>MaxFreqAsOAT2H</i>
28 ≤ OAT	No limit	

12.1.3.2 Target Frequency Setting for DCI 72/80

The compressor Target Speed is calculated according to the following formula:

$$Target\ Speed_{load} = \max \left[MiniSpeed, MaxSpeed \cdot \frac{ODUNload}{127} \right]$$

MiniSpeed, *MaxSpeed* are defined as following:

When the unit is in the cool mode, *MiniSpeedC* = 15Hz, *MaxSpeed* = 75Hz

When the unit is in the heat mode, *MiniSpeedH* = 20Hz, *MaxSpeed* = 95Hz

ODUNLOAD is calculated according to the IDU NLoad:

$$ODUNLOAD = \min \left\{ \frac{3 * IDUNLOAD}{ODUCode}, 127 \right\}$$

OAT	ODUCodeC	ODUCodeH	IDUNLOAD
≤-5	3	3	Refer to sect. <u>112.1.2.1</u>
≤-5	3.8	3	

12.1.4 Frequency Changes Control

When the unit is running normally , the compressor frequency change rate is 1 Hz/sec.

12.1.5 Compressor Starting Control

12.1.5.1 Compressor starting control for DCI50/60/72Zzz

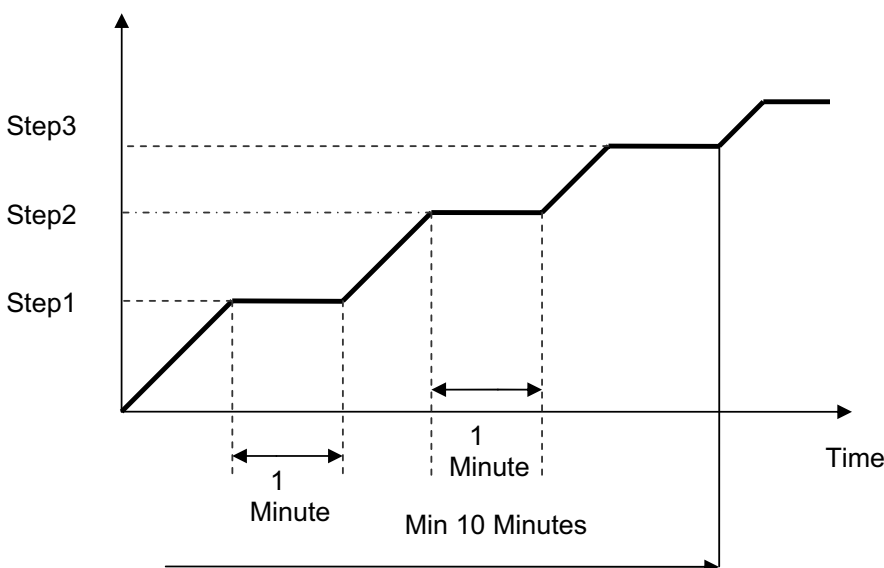

12.1.5.2 Compressor starting control for DCI72/80

Step 1

Whenever the compressor starts up, after it has been off for more than 45 minutes, the compressor frequency cannot go below *Step1RPS* for 3 continuous minutes (*this rule comes to ensure oil return to the compressor*).

Step 2

The compressor speed cannot go above *Step2RPS* once after each compressor start up for 3 continuous minutes (*this rule comes to prevent oil exit from the compressor after its start up*).

Step 3

The speed cannot go higher than *Step3RPS* unless it was operating for more than 1 continuous minutes between *Step3RPS – 5* and *Step3RPS*.

After passing above *Step3RPS*, this rule is re-applied when passing below *Step3RPS-5*.

12.1.6 Minimum On and Off Time

3 minutes

12.1.7 Indoor Fan Control

8 Indoor fan speeds are determined for each model. 4 speeds for cool/dry/fan modes and 4 speeds for heat mode.

When user sets the indoor fan speed to a fixed speed (Low/ Medium/ High), unit will operate constantly at set speed.

When Auto Fan is selected, indoor unit controller can operate in all speeds. The actual speed is set according to the cool/heat load.

12.1.7.1 Turbo Speed

The Turbo speed is activated during the first 30 minutes of unit operation when auto fan speed is selected and under the following conditions:

Difference between set point and actual room temperature is bigger then 3 degrees.

Room temperature > 22 for cooling, or < 25 for heating.

12.1.8 Outdoor Fan Control

12.1.8.1 Outdoor Fan Control for DCI50/60

7 outdoor fan speeds are determined for each model. 3 speeds for cool and dry modes, and 3 speeds for heat mode, and a very low speed.

Outdoor fan speed is a function of compressor frequency and outdoor air temperature (OAT).

4 routines for fan control are determined. The control routine selection depends on operation mode, compressor speed, outdoor air temperature (OAT) and heat sink temperature (HST).

Routine	Conditions
A	Heating with OAT < 15°C or Cooling with OAT > 20°C, or Faulty OAT
B	Cooling with 20°C > OAT > 7°C
C	Cooling with 7°C > OAT
D	Heating with OAT > 15°C

Compressor Target Frequency	OFAN Speed			
	Routin A	Routin B	Routin C	Routin D
Freq=0	OFF	OFF	OFF	OFF
$10 \leq \text{Freq} < \text{OFLowFreq}$	Low	Low	VL	Low
$\text{OFLowFreq} \leq \text{Freq} < \text{OFMedFreq}$	Medium	Low	VL	Low
$\text{OFMedFreq} \leq \text{Freq}$	High	Low	Low	Medium

When compressor is switched to OFF and the heat sink temperature is above 55 degrees, the outdoor fan will remain ON in low speed for up to 3 minutes.

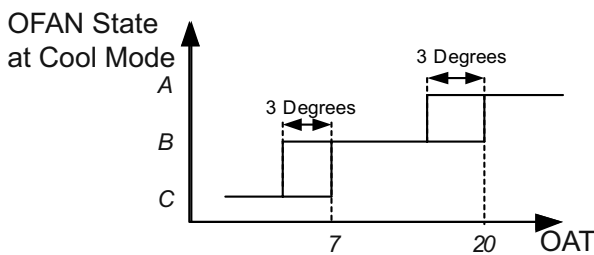

Note: Periorities A>B>C

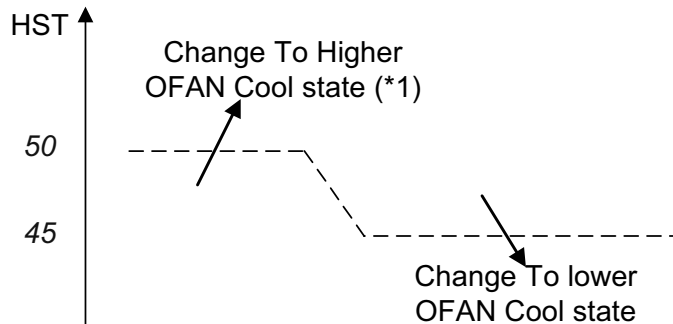

(*1) If State C, change to B
If State B, change to A

12.1.8.2 Outdoor Fan Control for DCI72/72Z/80

OFAN operates between any speed *OFMinRPM* to *OFMaxRPM*.

The fan speed is also related to protections and OMT value.

* For DCI 72Z, in heating mode the OFAN speed is related to OCT.

12.1.9 EEV (Electronic Expansion Vavle) Control

12.1.9.1 EEV Control for DCI50/60

EEV opening is defined as $EEV = EEVOL + EEVCV$

EEVOL is the initial EEV opening as a function of the compressor frequency, operation mode, unit model and capacity.

EEVCV is a correction value for the EEV opening that is based on the compressor temperature.

During the first 5 minutes of compressor operation $EEVCV = 0$.

Once the first 5 minutes are over, the correction value is calculated as follow: $EEVCV(n) = EEVCV(n-1) + EEVCTT$

EEVCTT is the correction based on the compressor temperature. A target compressor temperature is set depending on frequency and outdoor air temperature, and the actual compressor temperature is compared to the target temperature to set the required correction to the EEV opening.

12.1.9.2 EEV Control for DCI72/72Z/80

The target EEV value is the sum of open loop value (OL) and a result of the accumulative correction values (CV).

$$EEV = EEV_{OL} + \sum EEV_{CV}$$

The EEV initial value(OL) is defined as follow:

$$EEV_{OL} = EEV_{BaseOpenLoop} + EEV_{OpenLoopCpctyCrct} + EEV_{TubeCompnst}$$

Basic EEV open loop		Open Loop correction	EEV tube Length compensation
Mode	72/80	72/80	72/80
COOL	220	25	0
HEAT	170	30	0

*For DCI72Z

The initial EEV_{OL} is defined in accordance to the compressor frequency

EEV_{CV} is a correction value for the EEV opening that is based on the compressor temperature, During the first 6 minutes after SB the correction is not calculated. After that the correction value is updated every 30 seconds.

12.1.10 RV(Reversing Valve) Control

Reversing valve is on in heat mode.

Switching of RV state is done only after compressor is off for over 3 minutes.

12.1.11 Ioniser Control

Ioniser is on when unit is on ,AND indoor fan is on ,AND Ioniser power switch (on Ioniser) is on.

12.1.12 Base Heater Control

The base heater will be working only when RV is “ON” according to the following graph:

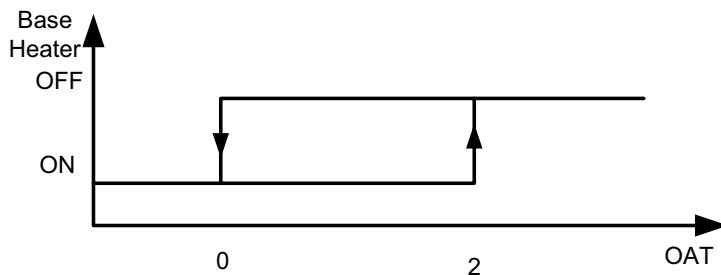

When OAT is faulty the base heater will be “ON” continuously in HEAT mode.

12.2 Fan Mode

In high/ medium/ low indoor fan user setting, unit will operate fan in selected speed.

In AutoFan user setting, fan speed will be adjusted automatically according to the difference between actual room temperature and user set point temperature.

12.3 Cool Mode

NLOAD is calculated according to the difference between actual room temperature and user set point temperature by PI control.

In high/ medium/ low indoor fan user setting, unit will operate fan in selected speed.

In AutoFan user setting, fan speed will be adjusted automatically according to the calculated NLOAD.

12.4 Heat Mode

NLOAD is calculated according to the difference between actual room temperature and user set point temperature by PI control.

In high/ medium/ low indoor fan user setting, unit will operate fan in selected speed.

In AutoFan user setting, fan speed will be adjusted automatically according to the calculated NLOAD.

12.4.1 Temperature Compensation

In wall mounted, ducted, and cassette models, 3 degrees are reduced from room temperature reading (except when in I-Feel mode), to compensate for temperature difference between high and low areas in the heated room, and for coil heat radiation on room thermistor.

The temperature compensation can be enabled/disabled by shortening of J2 on the indoor unit Controller

Model	J2 Shorted	J2 Opened
Wall mounted	Compensation Disabled	Compensation Enabled
Cassette	Compensation Enabled	Compensation Disabled
Ducted	Compensation Enabled	Compensation Disabled
Floor/Ceiling	Compensation Disabled	Compensation Enabled

12.4.2 Indoor Fan Control in Heating Mode

Indoor fan speed depends on the indoor coil temperature:

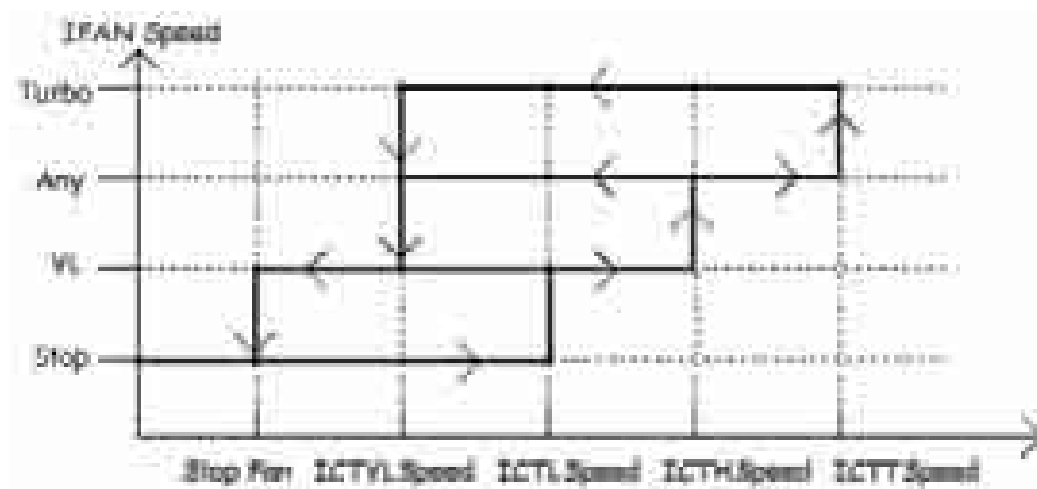

12.5 Auto Cool/Heat Mode

When in auto cool heat mode unit will automatically select between cool and heat mode according to the difference between actual room temperature and user set point temperature (.T). Unit will switch from cool to heat when compressor is off for 3 minutes, and $.T < -3$.

Unit will switch from heat to cool when compressor is off for 5 minutes, and $.T < -3$.

12.6 Dry Mode

As long as room temperature is higher than the set point, indoor fan will work in low speed and compressor will work between 0 and *MaxNLOADIF1C* Hz.

When the room temperature is lower than the set point, compressor will be switched OFF and indoor fan will cycle 3 minutes OFF, 1 minute ON.

12.7 Protections

There are 5 protection codes.

Normal (Norm) – unit operate normally.

Stop Rise (SR) – compressor frequency can not be raised but does not have to be decreased.

HzDown1 (D1) – Compressor frequency is reduced by 2 to 5 Hz per minute.

HzDown2 (D2) – Compressor frequency is reduced by 5 to 10 Hz per minute.

Stop Compressor (SC) – Compressor is stopped.

12.7.1 Indoor Coil Defrost Protection

ICT	ICT Trend				
	Fast Increasing	Increasing	No Change	Decreasing	Fast
ICT < -2	SC	SC	SC	SC	SC
-2 ≤ ICT < 0	D1	D1	D2	D2	D2
0 ≤ ICT < 2	SR	SR	D1	D2	D2
2 ≤ ICT < 4	SR	SR	SR	D1	D2
4 ≤ ICT < 6	Norm	Norm	SR	SR	D1
6 ≤ ICT ≤ 8	Norm	Norm	Norm	SR	SR
ICT > 8			Norm		

12.7.2 Indoor Coil Overheating Protection

12.7.2.1 Indoor Coil Overheating Protection For 50/60/72Z

ICT	ICT Trend				
	Fast Decreasing	Decreasing	No Change	Increasing	Fast Increasing
ICT > 62	SC	SC	SC	SC	SC
60 ≤ ICT < 62	D1	D1	D2	D2	D2
55 ≤ ICT < 60	SR	SR	D1	D2	D2
52 ≤ ICT < 55	SR	SR	SR	D1	D2
48 ≤ ICT < 52	Norm	Norm	SR	SR	D1
45 ≤ ICT ≤ 48	Norm	Norm	Norm	SR	SR
ICT < 45			Norm		

12.7.2.2 Indoor Coil Overheating Protection For 72/80

ICT	ICT Trend				
	<-2	-2	-1,0,1	2	>2
ICT >62	SC	SC	SC	SC	SC
60 ≤ ICT < 62	D1	D1	D2	D2	D2
58 ≤ ICT < 60	SR	SR	D1	D2	D2
56 ≤ ICT < 58	SR	SR	SR	D1	D2
54 ≤ ICT < 56	Norm	Norm	SR	SR	D1
52 ≤ ICT ≤ 54	Norm	Norm	Norm	SR	SR
ICT < 52	Norm				

12.7.3 Compressor Overheating Protection

12.7.3.1 Compressor Overheating Protection for DCI50/60/72Z

Compressor temperature can be in one of 5 control zones (4 in protection, and 1 normal), according to the following chart.

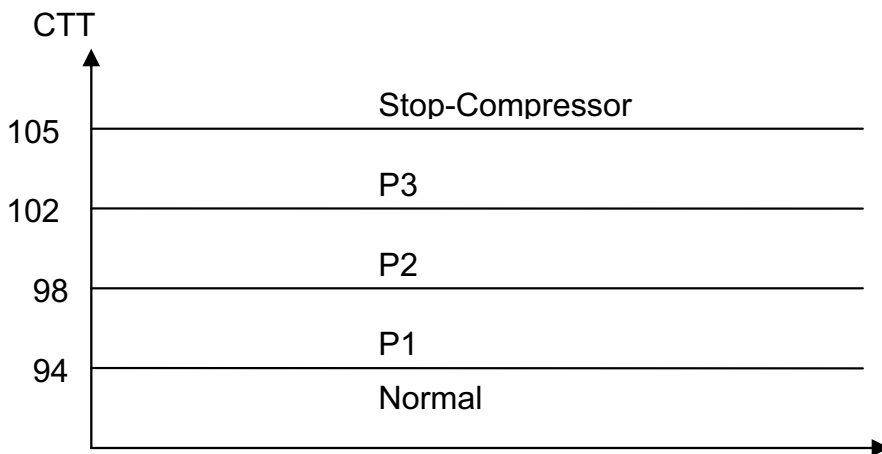

Control Status	Compressor Temperature Increases	Else
P1	Normal	Stop Rise
P2	HzDown 1	Stop Rise
P3	HzDown 2	HzDown 1
Stop Compressor	Stop Compressor	

12.7.3.2 Compressor Overheating Protection for DCI72/80

CTT		CTT Trend				
		Fast Decreasing	Decreasing	No Change	Increasing	Fast Increasing
Cool	Heat					
CTT >105	CTT >105	SC	SC	SC	SC	SC
100 ≤ CTT < 105	100 ≤ CTT < 105	D1	D1	D2	D2	D2
98 ≤ CTT < 100	95 ≤ CTT < 100	SR	SR	D1	D2	D2
93 ≤ CTT < 100	85 ≤ CTT < 95	SR	SR	SR	D1	D1
90 ≤ CTT ≤ 93	80 ≤ CTT ≤ 85	Norm	Norm	Norm	SR	SR
CTT < 90	CTT < 80	Norm				

12.7.4 Compressor Over Current Protection Only For DCI50/60/72Z

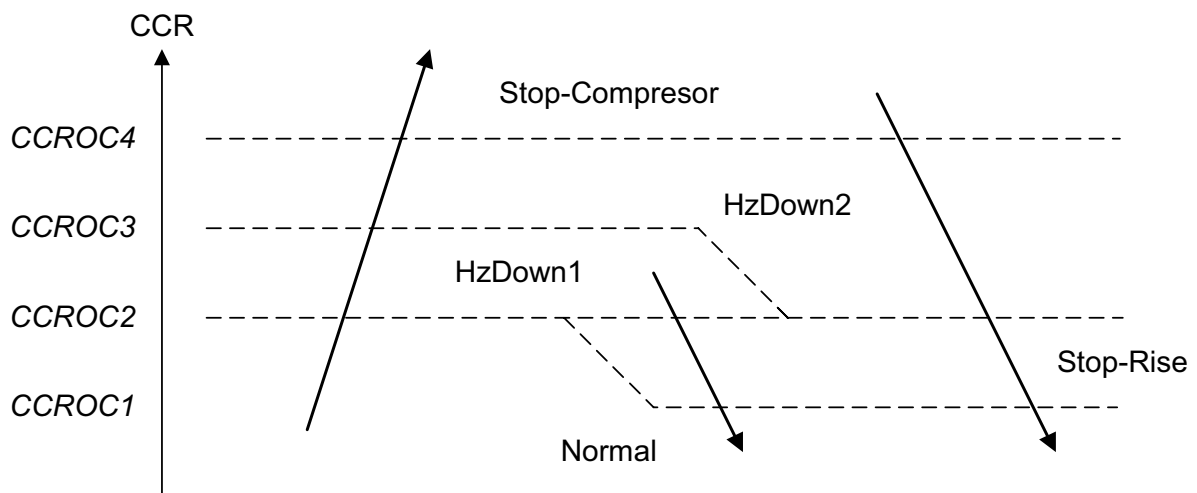

12.7.5 Heat Sink Overheating Protection

12.7.5.1 Heat Sink Overheating Protection For DCI50/60/72Z

HST	HST Trend				
	Fast Decreasing	Decreasing	No Change	Increasing	Fast Increasing
HST ≥ 90	SC	SC	SC	SC	SC
85 ≤ HST < 90	D1	D1	D2	D2	D2
82 ≤ HST < 85	SR	SR	D1	D2	D2
80 ≤ HST < 82	SR	SR	SR	D1	D1
78 ≤ HST ≤ 80	Norm	Norm	Norm	SR	SR
HST < 78	Norm				

12.7.5.2 Heat Sink Overheating Protection For DCI72/80

HST	Delta HST				
	<-2	-2	-1,0,1	2	>2
$HST \geq 81$	SC	SC	SC	SC	SC
$79 \leq HST < 81$	D1	D1	D2	D2	D2
$75 \leq HST < 79$	SR	SR	D1	D2	D2
$73 \leq HST < 75$	SR	SR	SR	D1	D1
$71 \leq HST \leq 73$	Norm	Norm	Norm	SR	SR
$HST < 71$	Norm				

12.7.6 System Over Power Protection Only For DCI72/80

Power		Delta PWR				
		< -2000	[-2000,0)	0	(0,2000]	> 2000
PWR1	PWR2					
$PWR \geq 3500$	$PWR \geq 2900$	SC	SC	SC	SC	SC
$3300 \leq PWR < 3500$	$2750 \leq PWR < 2900$	D1	D1	D2	D2	D2
$3100 \leq PWR < 3300$	$2600 \leq PWR < 2750$	SR	SR	D1	D2	D2
$3000 \leq PWR < 3100$	$2450 \leq PWR < 2600$	SR	SR	SR	D1	D1
$2950 \leq PWR \leq 3000$	$2300 \leq PWR \leq 2450$	Norm	Norm	Norm	SR	SR
$PWR < 2950$	$PWR < 2300$	Norm				

There are two sets of OVRPWR values, the selection of the values are set according to the state of the Power-Shed input.

Power-Shed input open Set values 1

Power-Shed input sort Set values 2

12.7.7 Outdoor Coil Deicing Protection

12.7.7.1 Outdoor coil Deicing Protection For DCI50/60/72Z

► Entering Deicing Conditions

Deicing operation will start when either one of the following conditions exist:

Case 1: $OCT < OAT - 8$ AND $TLD > DI$

Case 2: $OCT < OAT - 12$ AND $TLD > 30$ minutes.

Case 3: OCT is Invalid AND $TLD > DI$

Case 4: Unit is just switched to STBY AND $OCT < OAT - 8$

Case 5: $NLOAD = 0$ AND $OCT < OAT - 8$

Case 6: $OCT < -19$ AND $TLD > 60$ minutes

All this condition will exist during 10 seconds

OCT – Outdoor Coil Temperature

OAT – Outdoor Air Temperature

TLD – Time from Last Deicing

DI – Deicing Interval (Time Interval Between Two Deicing)

Deicing interval time when compressor is first started in heat mode, is 10 minutes if $OCT < -2$, and is 40 minutes in other cases.

Deicing interval time is changed (increased/ decreased in 10 minutes steps) as a function of deicing time. If deicing time is shorter then former deicing time, the deicing interval time will be increased. If deicing time is longer then former deicing time, the deicing interval time will be decreased.

► Deicing Operation Procedure

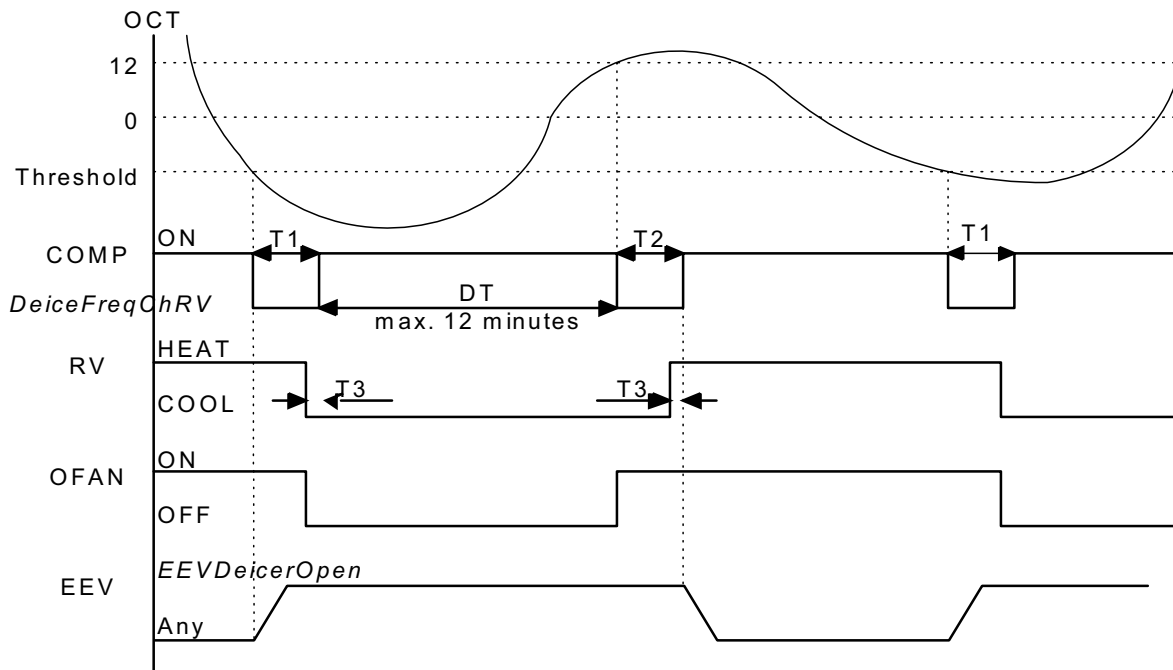

T1=60 secondes;T2=36 secondes;T3=6 secondes

12.7.7.2 Outdoor coil Deicing Protection For DCI72/80

► Entering Deicing Conditions

Deicing operation will start when either one of the following conditions exist:

Case 1: $OCT < OAT - 8$ AND $TLD > DI$

Case 2: $OCT < OAT - 12$ AND $TLD > 30$ minutes.

Case 3: OCT is Invalid AND $TLD > DI$

Case 4: Unit is just switched to STBY AND $OCT < OAT - 8$

Case 5: $NLOAD = 0$ AND $OCT < OAT - 8$

Case 6: OAT is invalid AND $OCT < 8$ AND $TLD > DI$ AND Compressor ON Time > 15 minutes

All this condition will exist during 400 seconds

OCT – Outdoor Coil Temperature

OAT – Outdoor Air Temperature

TLD – Time from Last Deicing

DI – Deicing Interval (Time Interval between Two Deicing)

Deicing interval time when compressor is first started in heat mode, is 10 minutes if $OCT < -2$, and is 40 minutes in other cases.

Deicing interval time is changed (increased/ decreased in 10 minutes steps) as a function of deicing time. If deicing time is shorter then former deicing time, the deicing interval time will be increased. If deicing time is longer then former deicing time, the deicing interval time will be decreased.

► Deicing Operation Procedure

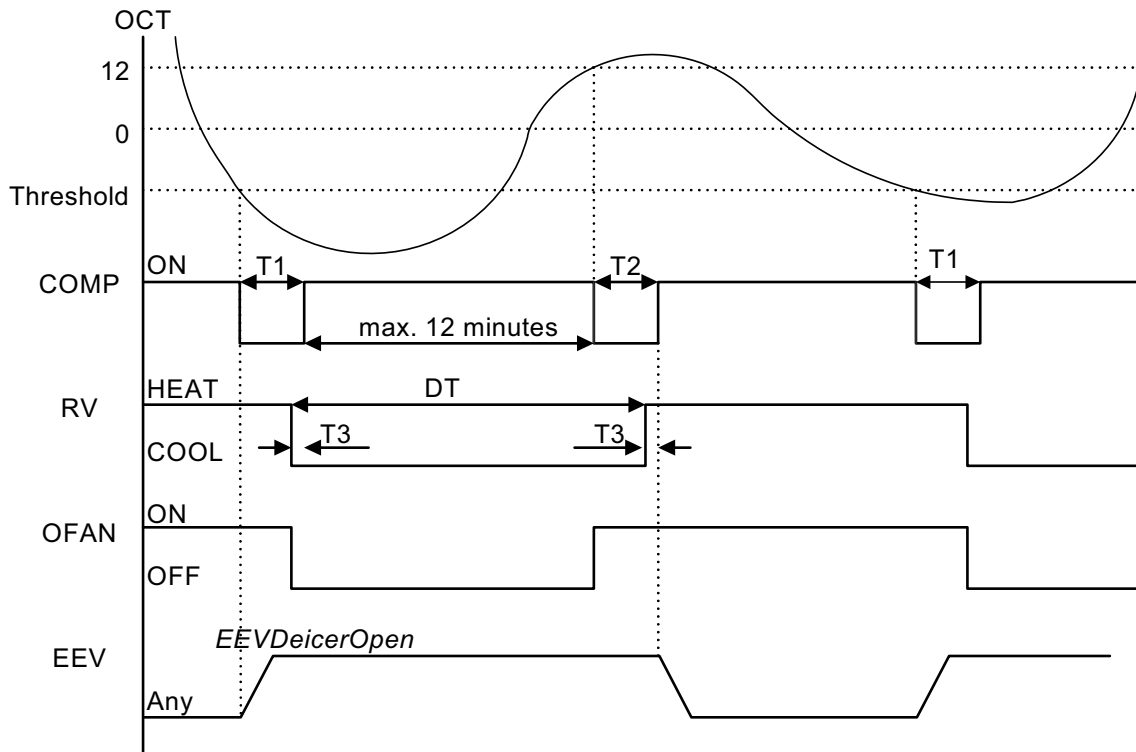

T1=50 secondes; T2=36 secondes; T3=6 secondes

12.7.8 Condensate Water Over Flow Protection



Each of the pins P1, P2, P3 can have two options:

- 1 – When it is shorted with P4
- 0 – When it is not shorted to P4

► Water Level Protection-1 level

P1	P2	P3	Level
Don't care	Don't care	1	Normal
Don't care	Don't care	0	Overflow

(*) 1- Pin P1, P2, or P3 is connected to P4.

0- Pin P1, P2 or P3 is not connected to P4.

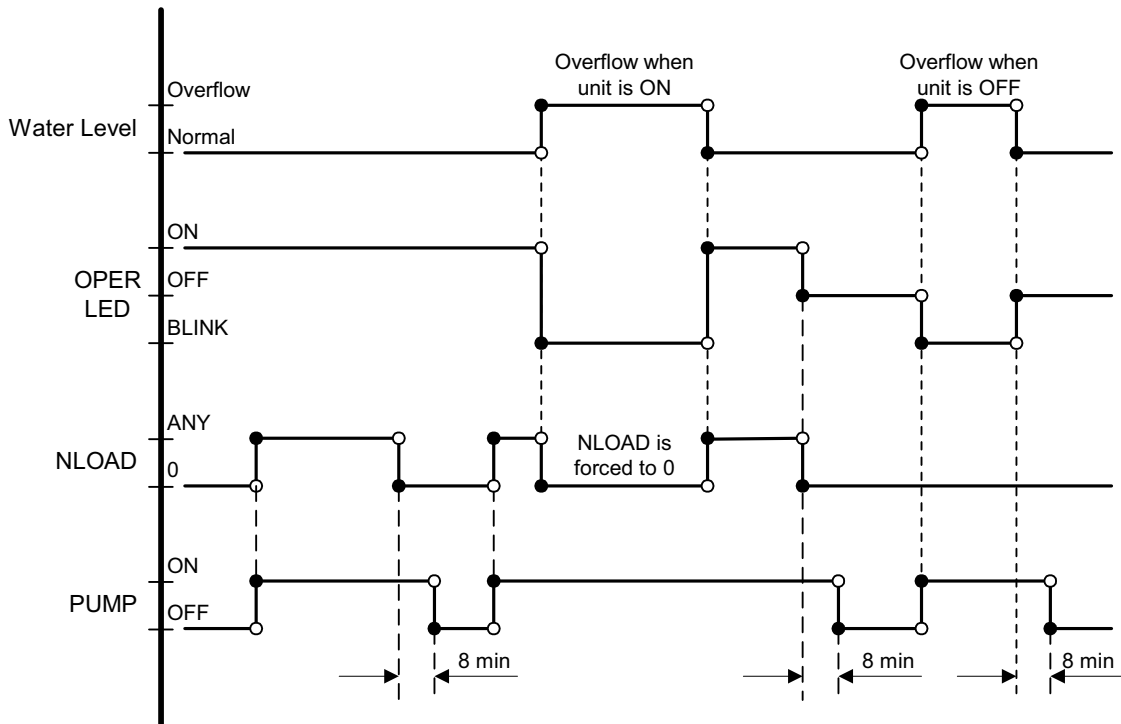

12.8 Indoor Unit Dry Contact

Indoor unit Dry contact has two alternative functions that are selected by J9.

	Function	Contact=open	Contact=short
J9=open	Presence Detector Connection	No limit	Force to STBY
J9=short	Power Shedding Function	No limit	Limit NLOAD

12.9 Operating the Unit from Mode Button

Forced operation allows to start, stop and operate in Cooling or Heating, in pre-set temperature according to the following table:

Forced operation Mode	Pre-set Temperature
Cooling	20°C
Heating	28°C

12.10 On Unit Controls and Indicators

12.10.1 Indoor Unit controller Controls and Indicators for All Models Except for Floor/Ceiling model

During OFF, Fan, Cool, Heat, Dry, and Auto modes (for operation in other modes, see at the relevant spec paragraph):

STAND BY INDICATOR	1. Lights up when the Air Conditioner is connected to power and ready to receive the R/C commands
OPERATION INDICATOR	1. Lights up during operation. 2. Blinks for 300 msec., to announce that a R/C infrared signal has been received and stored. 3. Blinks continuously during protections (according to the relevant spec section).
TIMER INDICATOR	Lights up during Timer and Sleep operation.
FILTER INDICATOR	Lights up when Air Filter needs to be cleaned.
COOLING INDICATOR	Lights up when system is switched to Cool Mode by using the Mode Switch <u>on the unit</u> .
HEATING INDICATOR	Lights up when system is switched Heat Mode by using the Mode Switch <u>on the unit</u> .
Mode SWITCH (COOL/HEAT/OFF)	Every short pressing , the next operation mode is selected, in this order : SB → Cool Mode → Heat Mode → SB → ... In long pressing system enters diagnostic mode.
RESET / FILTER SWITCH	For short pressing: When Filter LED is on - turn off the FILTER INDICATOR after a clean filter has been reinstalled. When Filter LED is off – enable/disable the buzzer announcer, if selected. In long pressing system enters set up mode (if in SB).

12.10.2 Outdoor Unit controller Indicators

Unit has three LED's.

SB LED is ON when power is ON (230 VAC, even when no communication).

STATUS LED is ON when COMP is ON, and Blinks according to diagnostics mode definitions when either fault or protection occurs.

FAULT LED Blinks according to diagnostics mode definitions when either fault or protection occurs.

12.11 Test Mode

12.11.1 Entering Test Mode

System can enter Test mode in two ways:

Automatically when the following conditions exists for 30 minutes continuously:

Mode = Cool, Set point = 16, Room temperature = $27(+1/-2)$, Outdoor temperature = $35(+2/-1)$

Or

Mode = Heat, Set point = 30, Room temperature = 20 ± 1 , Outdoor temperature = $7\pm(+1/-2)$

Manually when entering diagnostics with the following settings:

Mode = Cool, Set point = 16

Mode = Heat, Set point = 30

12.11.2 Unit Operation in Test Mode

In test mode, the unit will operate in fixed settings according to the indoor fan speed setting:

Indoor FAN Speed Setting	Unit Setting
Low	Minimum Capacity Setting
Turbo	Nominal Capacity Setting
Auto	Maximum Capacity Setting

During test mode, protections are disabled, except for stop compressor status.

12.12 SW Parameters

12.12.1 Indoor Units SW Parameters

Model dependent parametes - KN

	A (KN-60)	B (KN-72)	C (KN-80)
Cap .Group	3	4	4
NomLoadC	81	61	67
NomLoadH	77	59	67
MaxNLOADIF1C	55	44	85
MaxNLOADIF2C	70	50	102
MaxNLOADIF3C	127	120	120
MaxNLOADIF4C	127	127	127
MaxNLOADIF5C	127	127	127
MinRTC	20	20	20
MaxNLOADRTC	127	127	127
MaxNLOADIF1H	127	127	127
MaxNLOADIF2H	127	127	127
MaxNLOADIF3H	127	127	127
MaxNLOADIF4H	127	127	127
MaxNLOADIF5H	127	127	127
MaxNLOADRTH	127	127	127
MaxRTH	27	27	27
MaxNLOADPSC	81	61	67
MaxNLOADPSH	77	59	67

Model dependent parameters - DNG

Unit	A (DNG50)	B (DNG60)	C (DNG72)	D (DNG80)
Cap .Group	3	3	4	4
NomLoadC	62	77	57	60
NomLoadH	74	80	55	63
ICTSTSpeed	22	22	22	22
ICTVLSpeed	28	28	28	28
ICTLSpeed	30	30	30	30
ICTHSpeed	32	32	32	32
ICTTSpeed	40	40	40	40
MaxNLOADIF1C	50	50	63	78
MaxNLOADIF2C	63	63	85	100
MaxNLOADIF3C	120	120	115	127
MaxNLOADIF4C	127	127	127	127
MaxNLOADIF5C	127	127	127	127
MinRTC	20	20	20	20
MaxNLOADRTC	127	127	127	127
MaxNLOADIF1H	127	127	127	127
MaxNLOADIF2H	127	127	127	127
MaxNLOADIF3H	127	127	127	127
MaxNLOADIF4H	127	127	127	127
MaxNLOADIF5H	127	127	127	127
MaxNLOADRTH	127	127	127	127
MaxRTH	27	27	27	27
MaxNLOADPSC	62	77	57	60
MaxNLOADPSH	74	80	55	63

Model dependent parameters - WNG

Parameter name	(WNG) Wall Mounted Models					
	25	35	50	60	72	80
NLOAD limits as a function of selected indoor fan speed						
MaxNLOADIF1C	40	40	45	50	53	68
MaxNLOADIF2C	53	53	62	85	75	90
MaxNLOADIF3C	120	120	120	120	105	120
MaxNLOADIF4C	127	127	127	127	127	127
MaxNLOADIF5C	127	127	127	127	127	127
Indoor Fan speeds						
IFVLOWC	700	700	700	800	850	850
IFLOWC	800	800	900	1000	1000	1000
IFMEDC	900	950	1050	1100	1150	1150
IFHIGHC	1050	1100	1200	1250	1350	1300
IFTURBOC	1150	1200	1250	1300	1400	1350
IFVLOWH	700	700	700	800	900	900
IFLOWH	800	850	900	950	1050	1050
IFMEDH	950	1000	1100	1150	1200	1200
IFHIGHH	1100	1150	1250	1250	1350	1300
IFTURBOH	1200	1250	1300	1300	1400	1350

Model dependent parameters - PXD

Unit	A (PXD50)	B (PXD60)	C (PXD72)	D (PXD80)
Cap .Group	3	3	4	4
NomLoadC	68	80	60	63
NomLoadH	77	82	60	67
MaxNLOADIF1C	40	50	127	127
MaxNLOADIF2C	60	85	127	127
MaxNLOADIF3C	90	127	127	127
MaxNLOADIF4C	90	127	127	127
MaxNLOADIF5C	90	127	127	127
MinRTC	20	20	20	20
MaxNLOADRTC	127	127	127	127
MaxNLOADIF1H	127	127	127	127
MaxNLOADIF2H	127	127	127	127
MaxNLOADIF3H	127	127	127	127
MaxNLOADIF4H	127	127	127	127
MaxNLOADIF5H	127	127	127	127
MaxNLOADRTH	127	127	127	127
MaxRTH	27	27	27	27
MaxNLOADPSC	68	80	60	63
MaxNLOADPSH	77	82	60	67

12.12.2 Outdoor Units SW Parameters:**Model dependent parameters for DCI50/60**

#	Name	Single DCI-50	Single DCI 60
1	MinFreqC	20	20
2	MaxFreqC	85	95
3	MinFreqH	20	26
4	MaxFreqH	95	94
5	NormAccel	1	1
6	NormDecel	1	1
7	Step1Freq	60	60
8	Step2Freq	70	70
9	Step3Freq	90	90
10	OFVL	20	20
11	OFLOWC	60	55
12	OFMEDC	76	70
13	OFMAXC	92	79
14	OFLOWH	60	55
15	OFMEDH	83	70
16	OFMAXH	100	79
17	OFANTESTMODEC	92	83
18	OFANTESTMODEH	100	83
19	OFDeITestMode	28	28
20	CTTOH1	94	94
21	CTTOH2	98	98
22	CTTOH3	102	102
23	CTTOH4	105	105
24	CCROC1	10	11.4
25	CCROC2	10.5	11.8
26	CCROC3	10.8	12.2
27	CCROC4	11.2	12.6
28	DEICT1	60	60
29	DEICT2	36	36
30	DEICT3	6	6
31	ProtFreqLimit	60	60
32	EEVDecierOpen	100	180
33	OptimDeicFreq	90	90
34	EEVMinOperOpenC	50	80
35	EEVMaxOperOpenC	380	380
36	EEVMinOperOpenH	50	60
37	EEVMaxOperOpenH	380	300
38	EEVNormRate	33	33
39	EEVHighRate	12	12
40	EEVMaxOpen	500	500
41	OFLowFreqC	40	35
42	OFMedFreqC	70	55
43	OFLowFreqH	40	40
44	OFMedFreqH	86	60
45	HeaterDisableFlag	0	0
46	DeiceFreqChRV	0	0
47	OATRefC	35	35
48	SUCT Enable	0	0
49	HST Enable	1	1
50	OAT Enable	1	1
51	OATRefH	7	7
52	MinTargCTTC	30	30
53	MaxTargCTTC	95	90
54	MinTargCTTH	40	45
55	MaxTargCTTH	95	90
56	DST	8	8
57	DSTF	12	12
58	OATLimitC	28	28
59	OATLimit1H	6	6
60	OATLimit2H	15	15
61	MaxFreqAsOATC	64	85
62	MaxFreqAsOAT1H	85	80
63	MaxFreqAsOAT2H	60	60

Model dependent parameters for DCI72Z

No.	Name	Single DCI-72Z
1	MinFreqC	15
2	MaxFreqC	70
3	MinFreqH	15
4	MaxFreqH	90
7	Step1Freq	35
8	Step2Freq	55
9	Step3Freq	90
10	OFMinRPM	8
11	OFMaxRPM	90
12	NightRPM	65
13	OFNNoiseMaxRPM	78
14	CTTOH1	90
15	CTTOH2	95
16	CTTOH3	100
17	CTTOH4	105
18	CCROC1	12.5
19	CCROC2	13.3
20	CCROC3	14.1
21	CCROC4	14.9
22	ProtFreqLimit	60
23	EEVMinOperOpenC	50
24	EEVMaxOperOpenC	480
25	EEVMinOperOpenH	50
26	EEVMaxOperOpenH	480
27	HeaterDisableFlag	0
28	HST Enable	1
29	OATLimitC	24
30	OATLimit1H	6
31	OATLimit2H	15
32	MaxFreqAsOATC	60
33	MaxFreqAsOAT1H	85
34	MaxFreqAsOAT2H	75
35	NormAccel	1
36	NormDecel	1

Model dependent parameters for DCI72/80

Compressor Parameters	Value
<i>MinOFFTime</i>	3
<i>MinOnTime</i>	3
<i>MaxCTT1</i>	90
<i>MaxCTT2</i>	90
<i>MinSpeedAsCTT1</i>	26
<i>MinSpeedAsCTT2</i>	26
<i>MaxSpeedC</i>	75
<i>MaxSpeedH</i>	95
<i>Step1RPS</i>	40
<i>Step2RPS</i>	60
<i>Step3RPS</i>	75
<i>NormAcc (sec/RPS)</i>	1
<i>NormDec (sec/RPS)</i>	1
<i>Down1(Sec/RPS)</i>	12
<i>Down2 (Sec/RPS)</i>	7
<i>DeiceAcc (Sec/RPS)</i>	0.2
<i>DeiceDec (Sec/RPS)</i>	0.5

EEV Parameters	Value
<i>NormEEVRate</i>	30
<i>EEVCompOFFOpen</i>	200
<i>EEVCompOFFTime</i>	60
<i>EEVMaxOpen</i>	500
<i>EEVMinOperOpenC</i>	60
<i>EEVMaxOperOpenC</i>	500
<i>EEVMinOperOpenH</i>	70
<i>EEVMaxOperOpenH</i>	500
<i>EEVMinOperOpenHInIDU</i>	60
<i>EEVMaxOperOpenHInIDU</i>	140
<i>EEVIDUOFFOpen</i>	130
<i>EEVMoveSteps</i>	20
<i>EEVConstC</i>	30
<i>EEVConstH</i>	30
<i>BlncTimTrnsStC</i>	1
<i>BlncTimStdyStC</i>	1
<i>BlncTimTrnsStH</i>	1
<i>BlncTimStdyStH</i>	1
<i>CompOffTimToTrnsSt</i>	20

13. TROUBLESHOOTING

13.1 Troubleshooting for DCI50/60/72Z

<p><u>WARNING!!!</u></p> <p>When Power Up – the whole outdoor unit controller, including the wiring, is under HIGH VOLTAGE!!!</p> <p>Never open the Outdoor unit before turning off the Power!!!</p> <p>When turned off, the system is still charged (400V)!!!</p> <p>It takes about 3 Min. to discharge the system.</p> <p>Touching the controller before discharging may cause an electrical shock!!!</p>
--

13.1.1 Single Split System failures and Corrective Actions

No	Symptom	Probable Cause	Corrective Action
1	Power supply indicator (Red LED) does not light up.	No power supply	Check power supply. If power supply is OK, check display and display wiring. if OK, replace controller.
2	Unit does not respond to remote control message	Remote control message not reached the indoor unit	Check remote control batteries, if batteries are OK, check display and display wiring, if OK, replace display PCB. If still not OK replace controller.
3	Unit responds to remote control message but Operate indicator (Green LED) does not light up	Problem with display PCB	Replace display PCB. If still not OK replace controller.
4	Indoor fan does not start (louvers are opened and Green LED does light up)	Unit in heat mode and coil is still not warm.	Change to cool mode and check.
		Problem with PCB or capacitor	Change to high speed and Check power supply to motor is higher than 130VAC (for triack controlled motor) or higher than 220VAC for fixed speed motors, if OK replace capacitor, if not OK replace controller.
5	Indoor fan works when unit is OFF, and indoor fan speed is not changed by remote control command.	PCB problem	Replace controller
6	Compressor does not start	Electronics control problem or protection	Perform diagnostics and follow the actions described.
7	Compressor stops during operation and Green LED remains on	Electronic control or power supply problem	Perform diagnostics and follow the actions described.
8	Compressor is on but outdoor fan does not work	Problem with outdoor electronics or outdoor fan	Check outdoor fan motor according to the procedure below, if not OK replace controller.

No	Symptom	Probable Cause	Corrective Action
9	Unit works in wrong mode (cool instead of heat or heat instead of cool)	Electronics or power connection to RV	Check RV power connections, if OK, check RV operation with direct 230VAC power supply, if OK, replace outdoor controller.
10	All components are operating properly but no cooling or no heating	Refrigerant leak	Check refrigeration system.
11	Compressor is over heated and unit does not generate capacity	EEV problem	Check EEV.
12	Units goes into protections and compressor is stopped with no clear reason	Control problem or refrigeration system problem	Perform diagnostics , and follow the actions described.
13	Compressor motor is generating noise and no suction occurs	Phase order to compressor is wrong	Check compressor phase order.
14	Water leakage from indoor unit	Indoor unit drainage tube is blocked	Check and open drainage tube.
15	Freezing of outdoor unit in heat mode and outdoor unit base is blocked with ice		Connect base heater.
16	Unit operates with wrong fan speeds or wrong frequency	Wrong jumper settings	Perform diagnostics, and check if units is operating by EEPROM parameters.

13.1.2 Checking the refrigeration system

Checking system pressures and other thermodynamic measures should be done when system is in Test Mode (in Test mode, system operates in fixed settings). The performance curves given in this manual are given for unit performance in test mode when high indoor fan speed is selected.

Entering test mode:

Set unit to Cool/16 degrees/High indoor fan speed, or Heat/30 degrees/High indoor fan speed, and enter diagnostics.

13.1.3 Judgment by Indoor/Outdoor Unit Diagnostics

Enter diagnostics mode - press for five seconds Mode button in any operation mode. Acknowledgment is by 3 short beeps and lights of COOL and HEAT LED's. Then, every short pressing of Mode button will scroll between Indoor and Outdoor unit diagnostic modes by the acknowledgment of 3 short beeps and lighting of COOL and HEAT LED's.

During the Outdoor unit diagnostics all four Indoor LED's (STBY, Operate, Filter and Timer) are blinking. When Indoor diagnostics is displayed, all four LED's (STBY, Operate, Filter and Timer) are ON.

When system enters diagnostics mode, only one fault code is shown. Order of priority is from the lower to the higher number. Diagnostics is continuously ON as long as power is ON. The current system operation mode will not be changed.

If no fault occurred in the system, no fault code will be displayed during normal operation mode. The last fault code will be displayed even if the system has recovered from that fault. The last fault will be deleted from the EEPROM after the system has exit diagnostics mode.

In diagnostics mode, system fault / status will be indicated by blinking of Heat & Cool LEDs.

The coding method will be as follows:

Heat LED will blink 5 times in 5 seconds, and then will be shut off for the next 5 seconds. Cool LED will blink during the same 5 seconds according to the following Indoor / Outdoor unit tables:

Note: 0 – OFF, 1-ON

13.1.4 Indoor Unit Diagnostics

No	Problem	5	4	3	2	1
1	RT-1 is disconnected	0	0	0	0	1
2	RT-1 is shorted	0	0	0	1	0
3	RT-2 is disconnected	0	0	0	1	1
4	RT-2 is shorted	0	0	1	0	0
5	Reserved	0	0	1	0	1
7	Communication mismatch	0	0	1	1	1
8	No Communication	0	1	0	0	0
9	No Encoder	0	1	0	0	1
10	Reserved	0	1	0	1	0
11	Outdoor Unit Fault	0	1	0	1	1
...	Reserved					
17	Defrost protection	1	0	0	0	1
18	Deicing Protection	1	0	0	1	0
19	Outdoor Unit Protection	1	0	0	1	1
20	Indoor Coil HP Protection	1	0	1	0	0
21	Overflow Protection	1	0	1	0	1
22	Reserved					
24	EEPROM Not Updated	1	1	0	0	0
25	Bad EEPROM	1	1	0	0	1
26	Bad Communication	1	1	0	1	0
27	Using EEPROM data	1	1	0	1	1
28	Model A	1	1	1	0	0
29	Model B	1	1	1	0	1
30	Model C	1	1	1	1	0
31	Model D	1	1	1	1	1

13.1.4.1 Indoor Unit Diagnostics and Corrective Actions

No.	Fault	Probable Cause	Corrective Action
1	Sensor failures of all types		Check sensor connections or replace sensor
2	Communication mismatch	Indoor and Outdoor controllers are with different versions	Replace Indoor controller
3	No Communication	Communication or grounding wiring is not good.	Check Indoor to Outdoor wiring and grounding
4	No Encoder	Indoor electronics or motor	Check motor wiring, if ok, replace motor, if still not ok, replace Indoor controller.
5	Outdoor Unit Fault	Outdoor controller problem	Switch to Outdoor diagnostics.
6	EEPROM Not Updated	System is using ROM parameters and not EEPROM parameters	No action, unless special parameters are required for unit operation.
7	Bad EEPROM		No action, unless special parameters are required for unit operation.
8	Bad Communication	Communication quality is low reliability	Check Indoor to Outdoor wiring and grounding
9	Using EEPROM data	No problem. System is using EEPROM parameters	
10	The power supply indicator (red led) doesn't light up.	There is no correct voltage between the line and neutral terminals on main P.C.B.	-If the voltage is low repair power supply. -If there is no voltage repair general wiring. -If there is correct voltage replace main or display P.C.B'S
11	The operating indicator (green led) does not light up	The remote control batteries are discharged	-Replace batteries of the remote control
12	The operating indicator (green led) does not light up when starting from unit..	Check main P.C.B and display P.C.B.	-Replace P.C.B if necessary.
13	The indoor fan does not function correctly.	Check the voltage between indoor fan terminals on the main P.C.B	- If there is voltage replace capacitor or motor.

No.	Fault	Probable Cause	Corrective Action
14	The outdoor fan does not function correctly.	<p>Check the voltage between indoor fan terminals on the main P.C.B.</p> <p>There is voltage between outdoor fan terminals on the outdoor unit.</p> <p>There is no voltage between outdoor fan terminals on the outdoor unit.</p>	<p>- If there is no voltage replace main P.C.B</p> <p>- Replace capacitor or motor.</p> <p>- Check and repair electrical wiring between indoor and outdoor units.</p>
15	The compressor does not start up.	<p>Check voltage on compressor terminals on the outdoor unit. (with ampmeter)</p> <p>Check if there is correct voltage between compressor terminals on the outdoor unit.</p>	<p>-If no voltage replace main P.C.B.</p> <p>- If low voltage repair power supply.</p> <p>-If the voltage correct replace capacitor or compressor.</p> <p>-If there is no voltage repair electrical wiring between indoor and outdoor units.</p>
16	The refrigeration system does not function correctly.	Check for leaks or restrictions, with ampmeter, pressure guage or surface thermometer.	- Repair refrigeration system and charge refrigerant if necessary.
17	No cooling or heating only indoor fan works.	Outdoor fan motor faulty or other fault caused, compressor overload protection cut out.	<p>-Replace P.C.B.</p> <p>- Outdoor fan blocked remove obstructions.</p>
18	Only indoor fan and compressor working.	Outdoor fan blocked.	- Remove obstructions.
19	Only indoor fan working.	<p>-Run capacitor of outdoor fan motor faulty.</p> <p>-Windings of outdoor fan are shorted.</p>	<p>- Replace capacitor.</p> <p>-Replace motor.</p>

No.	Fault	Probable Cause	Corrective Action
20	No cooling or heating takes place, indoor and outdoor fans working.	<ul style="list-style-type: none"> - Overload safety device on compressor is cut out (low voltage or high temperature) - Compressor run capacitor faulty. - Compressor windings are shorted. 	<ul style="list-style-type: none"> - Check for proper voltage, switch off power and try again after one hour. - Replace compressor capacitor. - Replace compressor.
21	No air supply at indoor unit, compressor operates.	<ul style="list-style-type: none"> -Indoor fan motor is blocked or turns slowly. -indoor fan run capacitor faulty. - motor windings are shorted. 	<ul style="list-style-type: none"> - Check voltage,repair wiring if necessary. -Check fan wheel if it is tight enough on motor shaft,tighten if necessary. -Replace indoor fan motor.
22	Partial, limited air supply at indoor indoor unit.	Lack of refrigerant (will accompanied by whisteling noise) cause ice formation on indoor unit coil in cooling mode.	-Charge the unit after localizing leak.
23	Water accumulates and overflow from indoor unit section.	Drain tube or spout of drain pan clogged.	-Disassemble plastic drain tube from spout of indoor unit drain pan.
24	Water dripping from outdoor unit base. (in heating mode)	Water drain outlet is clogged.	-Open outdoor unit cover clean out water outlet ,clean the base inside throughly.
25	Freeze-up of outdoor coil in heating mode, poor heating effect in room, indoor fan operates.	<ul style="list-style-type: none"> -Faulty outdoor thermistor. -Faulty control cable. - Outdoor temperature is too low (below -2°C) -Outdoor unit air outlet is blocked. 	<ul style="list-style-type: none"> -Replace thermistor. - Repair control cable. - Shut unit off, outdoor temp. is below design conditions and cannot function properly. -Remove obstructions.

13.1.5 Outdoor Unit Diagnositis

No	Problem	5	4	3	2	1
1	OCT is disconnected	0	0	0	0	1
2	OCT is shorted	0	0	0	1	0
3	CTT is disconnected	0	0	0	1	1
4	CTT is shorted	0	0	1	0	0
5	HST is disconnected (when enabled)	0	0	1	0	1
6	HST is shorted (when enabled)	0	0	1	1	0
7	OAT is disconnected (when enabled)	0	0	1	1	1
8	OAT is shorted (when enabled)	0	1	0	0	0
9	TSUC is disconnected (when enabled)	0	1	0	0	1
10	TSUC is shorted (when enabled)	0	1	0	1	0
11	IPM Fault	0	1	0	1	1
12	Bad EEPROM	0	1	1	0	0
13	DC under voltage	0	1	1	0	1
14	DC over voltage	0	1	1	1	0
15	AC under voltage	0	1	1	1	1
16	Indoor / Outdoor unit Communication mismatch	1	0	0	0	0
17	No Communication	1	0	0	0	1
18	Reserved	1	0	0	1	0
20	Heat sink Over Heating	1	0	1	0	0
21	Deicing	1	0	1	0	1
22	Compressor Over Heating	1	0	1	1	0
23	Compressor Over Current	1	0	1	1	1
24	No OFAN Feedback	1	1	0	0	0
25	OFAN locked	1	1	0	0	1
26	Compressor Lock	1	1	0	1	0
27	Bad Communication	1	1	0	1	1

13.1.5.1 Outdoor Unit Diagnostics and Corrective Actions

No	Fault	Probable Cause	Corrective Action
1	Sensors failures of all types		Check sensors connections or replace sensors.
2	IPM Fault	Electronics HW problem	Check all wiring and jumper settings, if OK, replace electronics.
3	Bad EEPROM		No action, unless special parameters are required for unit operation.
4	DC under/over Voltage	Electronics HW problem	Check outdoor unit power supply voltage
5	AC under Voltage		Check outdoor unit power supply voltage
6	Indoor / Outdoor unit Communication mismatch	Indoor and Outdoor controllers are with different versions	Replace Indoor controller
7	No Communication	Communication or grounding wiring is not good.	Check Indoor to Outdoor wiring and grounding
8	Compressor Lock		Switch unit to STBY and restart
9	Bad Communication	Communication quality is low reliability	Check Indoor to Outdoor wiring and grounding

13.1.6 Judgment by MegaTool

MegaTool is a special tool to monitor the system states.

Using MegaTool requires:

A computer with RS232C port.

A connection wire for MegaTool.

A special MegaTool software.

Use MegaTool according to following procedure:

Setup MegaTool software: copy the software to the computer.

Connect RS232C port in computer with MegaTool port in Indoor/Outdoor unit controller by the connection wire.

Run the software and choose the COM port, you can monitor the A/C system state

In monitor tab

13.1.7 Simple procedures for checking the Main Parts

13.1.7.1 Checking Mains Voltage.

Confirm that the Mains voltage is between 198 and 264 VAC. If Mains voltage is out of this range, abnormal operation of the system is expected. If in range check the Power (Circuit) Breaker and look for broken or loosed cable lugs or wiring mistake(s).

13.1.7.2 Checking Power Input.

If Indoor unit power LED is unlighted, power down the system and check the fuse of the Indoor unit. If the fuse is OK replace the Indoor unit controller. If the fuse has blown, replace the fuse and power up again.

Checking Power Input procedure for the Outdoor unit is the same as with the Indoor unit.

13.1.7.3 Checking the Outdoor Fan Motor.

Enter Test Mode (where the OFAN speed is high)

Check the voltage between lead wires according to the normal value as following:

Between red wire and black wire: 310VDC +/- 20V

Between orange wire and black wire: 15VDC +/- 1V

Between yellow wire and black wire: 2-6VDC

13.1.7.4 Checking the Compressor.

The compressor is brushless permanence magnetic DC motor. Three coil resistance is same. Check the resistance between three poles. The normal value should be below 0.5 ohm (TBD).

13.1.7.5 Checking the Reverse Valve (RV).

Running in heating mode, check the voltage between two pins of reverse valve connector, normal voltage is 220VAC.

13.1.7.6 Checking the electrical expansion valve (EEV).

The EEV has two parts, drive part and valve. The drive part is a step motor; it is ringed on the valve. Check the drive voltage (12VDC). When Outdoor unit is power on, EEV shall run and have click and vibration.

13.1.8 Precaution, Advise and Notice Items

13.1.8.1 High voltage in Outdoor unit controller.

Whole controller, including the wires that are connected to the Outdoor unit controller may have the potential hazard voltage when power is on. Touching the Outdoor unit controller may cause an electrical shock.

Advise: Don't touch the naked lead wire and don't insert finger, conductor or anything else into the controller when power is on.

13.1.9 Charged Capacitors

Three large-capacity electrolytic capacitors are used in the Outdoor unit controller. Therefore, charging voltage (380VDC) remains after power down. Discharging takes about four minutes after power is off. Touching the Outdoor unit controller before discharging may cause an electrical shock.

13.1.10 Additional advises

When disassemble the controller or the front panel, turn off the power supply.

When connecting or disconnecting the connectors on the PCB, hold the whole housing, don't pull the wire.

There are sharp fringes and sting on shell. Use gloves when disassemble the A/C units.

13.2 Troubleshooting for DCI72/80

WARNING!!!

When Power Up – the whole outdoor unit controller, including the wiring, is under
HIGH VOLTAGE!!!

Never open the Outdoor unit before turning off the Power!!!

When turned off, the system is still charged (400V)!!!

It takes about 1 Min. to discharge the system.

Touching the controller before discharging may cause an electrical shock!!!

13.2.1 General System Failures and Corrective Actions

No	Symptom	Probable Cause	Corrective Action
1	Indoor unit power supply indicator (Red LED) does not light up.	No power supply	Check power supply. If OK, check display and display wiring. if OK, replace controller
2	Indoor unit does not respond to remote control message	Remote control message not reached the indoor unit	Check remote control batteries, if OK, check display and display wiring, if OK, replace display PCB. If still not OK replace controller
3	Indoor unit responds to remote control message but Operate indicator (Green LED) does not light up	Problem with display PCB	Replace display PCB. If still not OK replace controller
4	Indoor fan does not start (louvers are opened and Green LED is ON)	Unit in heat mode and coil is still not warm	Change to cool mode
		Outdoor unit is in opposite mode	Change operation mode
		Problem with controller or capacitor	Change to high speed and Check power supply to motor is higher than 130VAC (for triack controlled motor) or higher than 220VAC for fixed speed motors, if OK replace capacitor, if not OK replace controller
5	Indoor fan works when unit is OFF, and indoor fan speed is not changed by remote control command.	Controller problem	Replace controller
6	Water leakage from indoor unit	Indoor unit drainage tube is blocked	Check and open drainage tube

No	Symptom	Probable Cause	Corrective Action
7	Outdoor unit display board and leds are off	No power supply	Check the connections and the wiring on the main terminal - Repair if needed.
		PFC Chock coil	Check the PFC Chock coil
		Burnt fuse	Check 20A fuse on the Filter
8	Compressor operates but no capacity	EEV problem	Check EEV
		Refrigerant leakage	Check refrigeration system
		Indoor coil block	Clean filters and/or remove block
		Outdoor coil block	Remove block and/or avoid air by-pass
9	Compressor is over heated and unit does not generate capacity	EEV problem	Check EEV
		Refrigerant leakage	Check refrigeration system)
		Indoor coil block	Clean filters and/or remove block
		Outdoor coil block	Remove block and/or avoid air by-pass
10	Compressor stops during operation	Electronic control	Check diagnostics
		Refrigerant leakage	Check refrigeration system
11	Unit is not operating	Communication problems	Check diagnostics
12	Compressor does not start	Electronics control problem or protection	
13	Unit works in wrong mode (cool instead of heat or heat instead of cool)	Electronics or RV problem	Check RV
14	All components are operating properly but no cooling or no heating	Refrigerant leak	Check refrigeration system
15	Compressor motor is generating noise and no suction occurs	Phase order to compressor is wrong	Check compressor phase order
16	Freezing of outdoor unit in heat mode and outdoor unit base is blocked with ice		Connect base heater
17	The unit stop suddenly during operation	EMC interference to the A/C unit	Check for EMC problems
18	Indoor unit(s) Indicator(s) leds may flicker		

No	Symptom	Probable Cause	Corrective Action
21	Other home appliances operation is faulty such as noise appears in the television picture, or the picture is distorted or static occurs in the radio sound	EMC interference by the A/C unit	Check for EMC problems
22	All others	Specific problems of indoor or outdoor units	Check diagnostics

13.2.2 Checking the refrigeration system

Checking system pressures and other thermodynamic measures should be done when system is in technician Mode where the system operates as in fixed settings. The performance curves given in this manual are given for unit performance in Technician mode when high indoor fan speed is selected.

13.2.3 Diagnostics

13.2.3.1 Outdoor unit diagnostics

If any fault exists in the system, it will be shown according to tlf no fault exists in the system, no fault code will be displayed during normal operation mode, and the status led will be on while the compressor is enable.he following coding method.

Two LEDs display the system diagnostics on real time as follows:

STATUS LED is blinking 5 times in 5 seconds, and shut off for the next 5 seconds.

FAULT LED will blink during the same 5 seconds according to the following table:

No	Problem	5	4	3	2	1
1	OCT bad	0	0	0	0	1
2	CTT bad	0	0	0	1	0
3	HST bad	0	0	0	1	1
4	OAT bad	0	0	1	0	0
5	OMT bad	0	0	1	0	1
6	RGT bad	0	0	1	1	0
7	OFAN/Compressor Feedback Loss	0	0	1	1	1
8	OFAN- IPM fault	0	1	0	0	0
9	OFAN Lock	0	1	0	0	1
10	OFAN- Vospd exceeded	0	1	0	1	0
11	Compressor- IPM Fault	0	1	0	1	1
12	Compressor Lock	0	1	1	0	0
13	Compressor- Vospd exceeded	0	1	1	0	1
14	Compressor- Foldback	0	1	1	1	0
15	DC under voltage	0	1	1	1	1
16	DC over voltage	1	0	0	0	0
17	AC under voltage	1	0	0	0	1
18	No communication A	1	0	0	1	0
19	reserved	1	0	0	1	1
20	reserved	1	0	1	0	0
21	reserved	1	0	1	0	1
22	Compressor- Illegal Speed	1	0	1	1	0
23	System Configuration Changed	1	0	1	1	1
24	System Configuration Problem	1	1	0	0	0
25	Heat sink Over Heating Fault/Protection	1	1	0	0	1
26	Deicing Protection	1	1	0	1	0
27	Compressor Over Heating Protection	1	1	0	1	1
28	System over power Protection	1	1	1	0	0
29	Bad EEPROM	1	1	1	0	1
30	Not Configured	1	1	1	1	0
31	Bad Communication	1	1	1	1	1

Notes:

1 - ON, 0 - OFF

Whenever this table is updated, the installation test procedure, and the alarm output function should be updated.

Only one code is shown.

Order of priority is 1-32. Diagnostics is continuously ON as long as power is on.

Heat Sink Over Heating Protection, Compressor Over Heating Protection, and System Over Power Protection are declared only whenever in 'Stop-Compressor' status.

All faults, except the thermistor faults, will remain at least 10 seconds. This rule comes to serve the monitoring utilities, in a case the fault is released quickly it will be still shown under the monitoring utilities.

Thermistor faults are reported only when they are enabled.

When the outdoor unit is in fault (not protection), an in-fault signal is sent to the indoor. When all the outdoor unit faults are cleared, 'no-fault' signal is sent to the indoor.

13.2.3.2 Outdoor fault corrective actions

No	Fault Name	Probable Cause	Corrective Action
1	OCT bad	Thermistor not connected or damaged	Check Thermistor
2	CTT bad		
3	HST bad		
4	OAT bad		
5	TSUC bad		
6	RGT bad		
7	OFAN/Compressor Feedback Loss	OFAN halls or wires bad. Compressor wire cable bad or IPM bad or compressor bad	Check OFAN motor and compressor
8	OFAN - IPM fault	Over current / Over temperature of OFAN IPM	Check no obstruction to controller air opening Check OFAN motor Check motor type matches motor jumpers in controller
9	OFAN Lock	Fan does not rotate	Check OFAN motor
10	OFAN- Vospd exceeded	Exceeds speed high limit	Check motor type matches motor jumpers in controller Make necessary arrangements in unit installation location to avoid back wind Avoid EMC problems
11	Compressor- IPM Fault	Over current / Over temperature of compressor IPM	Check no obstruction to controller air opening Check Compressor
12	Compressor Lock	Compressor does not rotate	Check Compressor
13	Compressor- Vospd exceeded	Exceeds speed limit	Try again and replace controller if still have the problem
14	Compressor- Foldback	High pressure / Current reduces compressor speed	Check Compressor
15	DC under voltage	DC voltage is lower than limit	Replace controller
16	DC over voltage	DC voltage exceeds its high limit	Check if input voltage higher than limit (270VAC), if not and the problem persist, replace controller. If voltage is high, shut off the power and recommend the customer to fix the power supply
17	AC under voltage	AC input voltage is lower than limit	Check if input voltage lower than limit (170VAC), if not and the problem persist, replace controller. If voltage is low, recommend the customer to fix the power supply

No	Fault Name	Probable Cause	Corrective Action
18	No communication A	No signals in line A	Check communication
19	Compressor- Illegal Speed	Exceeds speed low limit	See # 13
20	System Configuration Changed	Communication lines changed from last operation	No problem just an announcement
21	System Configuration Problem	Miss-match between the IDUs connected to port A,B,C or D, or the total capacity code of IDUs is higher than the ODU maximum capacity code	Change configuration if needed.
22	Heat sink Over Heating Fault/ Protection	Compressor stopped due to heatsink protection	Check that the airflow around the ODU is free and the fan is running free. Check fan motor (0)
23	Deicing Protection	During deicing procedure	No action required
24	Compressor Over Heating Protection	Compressor stopped due to over heat protection	Check if gas is missing in the system
25	System over power Protection	Compressor stopped due to over power protection	No action required
26	Bad EEPROM	EEPROM not operating	Power reset. (Replace Controller just in case you need EEPROM).
27	Not Configured	Cannot start the control	Power reset. Replace Controller if didn't help
28	Bad Communication	Bad communication lines	See # 18-21

13.2.4 Fault Code for Indoor unit

Pressing Mode button for long will activate diagnostic mode by the acknowledgment of 3 short beeps and lighting of COOL and HEAT LED's.

Entering diagnostics in STBY mode allows only viewing of status (fault-display).

In diagnostic mode, system problems / information will be indicated by blinking of Heat & Cool LED's.

The coding method will be as follows:

Heat led will blink 5 times in 5 seconds, and then will be shut off for the next 5 seconds. Cool Led will blink during the same 5 seconds according to the following table:

No	Fault Name	5	4	3	2	1
1	RT-1 is disconnected	0	0	0	0	1
2	RT-1 is shorted	0	0	0	1	0
3	RT-2 is disconnected	0	0	0	1	1
4	RT-2 is shorted	0	0	1	0	0
...	Reserved	0	0	1	0	1
7	Communication mismatch	0	0	1	1	1
8	No Communication	0	1	0	0	0
9	No Encoder	0	1	0	0	1
10	Reserved	0	1	0	1	0
11	Outdoor Unit Fault	0	1	0	1	1
...	Reserved					
17	Defrost protection	1	0	0	0	1
18	Deicing Protection	1	0	0	1	0
19	Outdoor Unit Protection	1	0	0	1	1
20	Indoor Coil HP Protection	1	0	1	0	0
21	Overflow Protection	1	0	1	0	1
...	Reserved					
24	EEPROM Not Updated	1	1	0	0	0
25	Bad EEPROM	1	1	0	0	1
26	Bad Communication	1	1	0	1	0
27	Using EEPROM data	1	1	0	1	1
28	Model A	1	1	1	0	0
29	Model B	1	1	1	0	1
30	Model C	1	1	1	1	0
31	Model D	1	1	1	1	1

1 - ON, 0 - OFF

Only one code is shown. Order of priority is lower to the higher number. Diagnostics is continuously ON as long power is on.

13.2.4.1 Indoor unit diagnostics and corrective actions

No.	Fault	Probable Cause	Corrective Action
1-4	Sensor failures	Sensors not connected or damaged	Check sensor connections or replace sensor
7	Communication mismatch	Indoor and Outdoor controllers are with different versions	Replace Indoor controller
8	No Communication	Communication or grounding wiring is not good	Check Indoor to Outdoor wiring and grounding
9	No Encoder	Indoor electronics or motor	Check motor wiring, if ok, replace motor, if still not ok, replace Indoor controller.
11	Outdoor Unit Fault	Outdoor controller problem	Switch to Outdoor diagnostics.
17-21	Protections	Indication	No action
24	EEPROM Not Updated	System is using ROM parameters and not EEPROM parameters	No action, unless special parameters are required for unit operation.
25	Bad EEPROM		No action, unless special parameters are required for unit operation.
26	Bad Communication	Communication quality is low reliability	Check Indoor to Outdoor wiring and grounding
27	Using EEPROM data	No problem	
28-31	IDU model		

13.2.5 Procedures for checking Main Parts

13.2.5.1 Checking Mains Voltage

Confirm that the Mains voltage is between 198 and 264 VAC. If Mains voltage is out of this range, abnormal operation of the system is expected. If in range check the Power (Circuit) Breaker and look for broken or loosed cable lugs or wiring mistake(s).

13.2.5.2 Checking Main fuse

Check 20A fuse on the Filter Board - If burnt – check the compressor, fan or any other peripheral that can cause a short. In case of a problematic peripheral - replace it.

In case no problematic peripheral, check the resistance on the DC bank (B+ & B- on the Power board), if it is less than 30Ω, replace the controller. Otherwise replace the burnt fuse. In case of frequent burning fuse, replace the controller.

13.2.5.3 Checking PFC Chock coil

Check PFC chock connection – repair if needed.

Dis-connect the chock from the controller wire extensions, check if the 2 wires of the chock are shorted. If shorted (OK) check between each wire and the metal box. If shorted replace chock, if not (OK), open the controller top cover and check if the wire extensions are connected well and if shorted. If not shorted, replace wires, if shorted (OK) than might be a controller problem – replace controller.

13.2.5.4 Checking the Outdoor Fan Motor

Check FAN-Power and FAN-Halls connections - Repair if needed.

Rotate the fan slowly by hand. If the fan does not rotate easily, check whether something is obstructing the fan, or if the fan itself is coming into contact with the outer case, preventing it from rotating. Correct if necessary - otherwise, the fan motor bearings have seized. Replace the motor.

If the fan rotates easily, use a current probe ("Clamp") to assure AC current on each phase and it is less than 1A.

In case there is no current, check the resistance between the three poles. Assure the three coil resistances are almost the same.

The normal value should be between 10 Ω to 20 Ω .

Change to Stand-by or Power OFF and re-start - If the fault is still active - replace controller.

13.2.5.5 Checking the Compressor

Check Compressor connections - Repair if needed.

Use a current probe ("Clamp") to assure that there is an AC current on each phase – no more than 15A.

In case there is no current, check the resistance between the three poles. Assure the three coil resistances are almost the same (between 0.8 Ω to 1.5 Ω).

Change to Stand-by or Power OFF and re-start - If the fault is still "Active" - replace controller.

13.2.5.6 Checking the Reverse Valve (RV)

The RV has two parts, Solenoid and valve.

Solenoid - Running in heating mode, check the voltage between two pins of reverse valve connector, normal voltage is 230VAC. if no power supply to RV, Check RV operation with direct 230VAC power supply, if OK, replace outdoor controller.

Valve - if RV solenoid is OK (as above) but still no heating operation while compressor is On, replace the valve.

13.2.5.7 Checking the electrical expansion valve (EEV)

The EEV has two parts, drive and valve.

When Outdoor unit is powered on, EEV shall run and have click and vibration.

For assuring the problem is of the EEV parts, perform the installation test and if fails and no other indications in the diagnostics, than the problem is with the EEV (one or more).

Drive - a step motor; ringed on the valve. Check the drive voltage, should be 12VDC.

Valve – if drive is OK (as above) but still the indoor unit perform no conditioning replace the valve (no need to take out the refrigerant, just pump down and shut off the main valves).

13.2.5.8 Checking the thermistors

Check Thermistor connections and wiring - Repair if needed.

Check Thermistor resistance – between 0°C and 40°C should be between 35K Ω and 5K Ω .

13.2.5.9 Checking the communication

Change to Stand-by or Power OFF and re-start - If the fault is still "Active" check Indoor to Outdoor. Communication wiring and grounding connections (should be less than 2.0 Ω) - Repair if needed.

If IDU failure – replace IDU controller that does not respond.

If ODU failure – replace ODU.

13.2.5.10 Checking for electromagnetic interference (EMC problems)

EMC troubles to the A/C unit

Locations most susceptible to noise :

1. Locations near broadcast stations where there are strong electromagnetic waves.
2. Locations near amateur radio (short wave) stations.
3. Locations near electronic sewing machines and arc-welding machines.

Trouble :

Either of the following trouble may occur:

1. The unit may stop suddenly during operation.
2. Indicator lamps may flicker

Correction :

The fundamental concept is to make the system less susceptible to noise (insulate for noise or distance from the noise source):

1. Use shielded wires.
2. Move unit away from the noise source.

13.2.5.11 EMC troubles to near by home appliances

Locations most susceptible to noise :

1. A television or radio is located near the A/C and A/C wiring.
2. The antenna cable for a television or radio is located close to the A/C and A/C wiring.
3. Locations where television and radio signals are weak.

Trouble :

1. Noise appears in the television picture, or the picture is distorted.
2. Static occurs in the radio sound.

Correction

1. Select a separate power source.
2. Keep the A/C and A/C wiring at least 1 meter away from wireless devices and antenna cables.
3. Change the wireless device's antenna to a high sensitivity antenna.
4. Change the antenna cable to a BS coaxial cable.
5. Use a noise filter (for the wireless device).
6. Use a signal booster.

13.2.6 Precaution, Advise and Notice Items

13.2.6.1 High voltage in Outdoor unit controller

Whole controller, including the wires, connected to the Outdoor unit controller may have the potential hazard voltage when power is on. Touching the Outdoor unit controller may cause an electrical shock.

Advise: Don't touch the naked lead wire and don't insert finger, conductor or anything else into the controller when power is on.

13.2.6.2 Charged Capacitors

Three large-capacity electrolytic capacitors are used in the Outdoor unit controller. Therefore, charging voltage (380VDC) remains after power down. Discharging takes about one minute after turned off. Touching the Outdoor unit controller before discharging may cause an electrical shock. When open the Outdoor unit controller cover, don't touch the soldering pin by hand or by any conductive material.

13.2.6.3 Advise:

Open the Outdoor unit controller cover only after one minute from power off.

Measure the electrolytic capacitors voltage before farther checking controller.

Additional advises

When disassemble the controller or the front panel, turn off the power supply.

When connecting or disconnecting the connectors on the PCB, hold the whole housing, don't pull the wire, there are sharp fringes and sting on shell. Use gloves when disassemble the A/C units.